

Spray guns



SG 41

SG 42

SG 43

SG 44

SG 45

Operating Manual
English
March 20 | Version 1.0



1. Table of Contents

Preface	4
Purpose of the document.....	4
2. ⚠ Safety	5
2.1 ⚠ Noncompliance with the safety information and its consequences	5
2.2 ⚠ Target group	5
2.3 ⚠ User requirements.....	5
2.4 ⚠ Explanation of general safety instructions	6
2.5 ⚠ Information provided in these operating instructions	6
2.6 ⚠ Intended use.....	7
2.7 ⚠ Safety warnings for modifications	8
2.8 ⚠ Protective equipment.....	8
2.9 ⚠ General safety instructions.....	10
3. Legal.....	12
3.1 Copyright	12
3.2 Exclusion of liability	12
3.3 Warranty conditions.....	12
4. Environment	13
4.1 Disposal.....	13
4.2 Environmental protection	13
5. Spray guns	14
5.1 Introduction.....	14
5.2 Application.....	14
5.3 Transport and storage	15
5.4 Technical data.....	15
5.5 Scope of supply.....	16
5.6 Flow table	17
5.7 Reaction forces	18

5.8 Torques 20

6. Installation..... 23

6.1 Assembly..... 23

6.2 Setting up the work area 23

7. Operation 24

7.1 Operating the spray guns 24

7.2 Replacing nozzle inserts..... 27

8. Maintenance..... 28

8.1 Inspections..... 28

8.2 Replacing the repair set 29

8.3 Cleaning 31

9. Accessories/spare parts..... 32

9.1 Shoulder support 32

9.2 Swivel joints 32

9.3 Repair sets 32

9.4 Lance heads 32

9.5 Gun nozzles..... 33

10.Index 34

11.Notes..... 35

Version	Revision	Date	Initials
1.0	Created	March 20	fkr

Preface

Dear Valued Customer,

Thank you for the confidence and trust you've placed in us by purchasing our products. We always appreciate any ideas for improvement and constructive suggestions. Your feedback will help us improve the design of our product and the associated documentation.

If you have any questions or suggestions, please contact our Customer Service Department:

enz® technik ag
Schwerzbachstrasse 10
6074 Giswil, Switzerland

Phone +41 41 676 77 66
Fax +41 41 676 77 67
info@enz.com
www.enz.com

Person responsible for documentation:
Fabian Krasniqi (Tech Support / QM Manager)

We reserve the right to modify and further enhance our products without prior notice as a result of technological advances. Misprints reserved.

Purpose of the document

The purpose of this manual is to instruct you on how to use our product correctly, effectively, safely, and for its intended purpose. The user will be informed about risks, reasonably foreseeable misuse, and residual risks.



Important!

Before using your product for the first time, read this original operating manual, follow it, and save it for later use.

Please read this operating manual thoroughly before using the cleaning tool. Make sure that all people who work with the product know how to use it correctly.

The operating manual must be available to all operating personnel at all times. It must be kept in an easily accessible place.

If the manual is misplaced or destroyed, a new copy can be requested from your nearest dealer or from the manufacturer directly.

2. ⚠ Safety

2.1 ⚠ Noncompliance with the safety instructions and its consequences

Disregarding these safety instructions may lead to accidents and severe personal injuries, material damage, and damage to the environment.

The manufacturer cannot be held responsible for any damage resulting from noncompliance with these instructions.

2.2 ⚠ Target group

This manual is intended for all persons who will be involved in the assembly, start-up and operation of high-pressure spray guns.

2.3 ⚠ User requirements

All persons involved with assembly, start-up, and operation of high-pressure spray guns must

- Be familiar with the field of cleaning work and possess the appropriate technical knowledge.
- Be trained and instructed appropriately in the use of the product.
- Have read and understood the operating manual, in particular the section on **Safety**.

If your personnel do not possess the necessary knowledge, they must be trained and instructed on it. If necessary, the cleaning tool supplier can provide this instruction and training.

Only the maintenance and service activities described in this manual may be performed by users who have met the above-listed requirements. Any additional maintenance and service work may be performed only by qualified specialist personnel from the manufacturer.



Please refer to the section on MAINTENANCE.

2.4 ⚠ Explanation of general safety instructions

The general safety instructions in this chapter provide information on the potential residual risks that are inherent in the product or may occur unexpectedly, despite its proper use.

In order to prevent personal injuries, material damage, and damage to the environment, all personnel working with this product must comply with these safety instructions. It is mandatory for said personnel to read and to understand the information provided in this section.

2.5 ⚠ Information provided in this operating manual



DANGER

Noncompliance may lead to severe injury or even **loss of life**.



WARNING

Noncompliance may lead to serious injury or even **loss of life** and/or cause a long-term disability.



CAUTION!

Noncompliance may lead to injuries and considerable material damage, financial losses or contamination of the environment.



Information on the technically correct and efficient use of the product.

2.6 ⚠ Intended use

Due to the high pressures and temperatures, there is a danger of material damage and a risk of injury for users and other persons. The following points must be observed to ensure proper use of the product:

- ⚠ The spray gun may **not** be operated with abrasive material.
- ⚠ Do **not** use the device if people who are not wearing protective clothing are in the area.
- ⚠ The reaction force may **not** exceed 150 N. With body support, a reaction force higher than 250 N is not allowed.
- ⚠ The product may be operated only with correct and faultless hose connections.
- ⚠ The maximum pressure indicated on the nozzle may **not** be exceeded.
- ⚠ Wastewater may **not** be drained into bodies of water (creeks, rivers, etc.).
- ⚠ The product must be inspected to ensure it is in proper working order before every start-up.
- ⚠ Defects must be rectified before start-up.
- ⚠ Use the tool only as intended. (Use only the correct wrench on nuts).
- ⚠ Secure the hose lines in such a way that they cannot become damaged during operation.
- ⚠ Only the accessories provided and approved by **enz® technik ag** may be used.

In addition, read the operating manual for the pressure generator to ensure that it is being used as intended.

2.7 ⚠ Safety warnings for modifications

The spray guns may be used only if they are in technically perfect condition, their construction has not been changed, and following the instructions in this user manual in terms of intended use, awareness of safety, and awareness of risk. Only adults who have been instructed on how to operate high-pressure cleaners may use the guns. The manufacturer is not liable for damage resulting from unauthorized changes to the product.

2.8 ⚠ Protective equipment

The employer must provide suitable personal protective equipment. He or she must ensure that it is worn by the employees during work. In the following section, the protective equipment prescribed by Schweizerische Unfallversicherung SUVA (the Swiss Accident Insurance Organization) will be described.

For more information on this, refer to the brochure:

Safe entry and working in manholes, excavation pits, and channels

Order number: 44062.d

Suva
 Schweizerische Unfallversicherungsanstalt
 Arbeitssicherheit
 Postfach, 6002 Lucerne, Switzerland
 For information:
 Phone +41 41 419 51 11
 For orders:
www.suva.ch/waswo
 Fax +41 41 419 59 17
 Phone +41 41 419 58 51



Respirators

Self-contained respiratory equipment for spending time in dangerous atmospheres and for use during rescue operations.



Respirators

Self-rescue respiratory equipment (devices with compressed air tanks or regeneration devices) for working in channels and for first aid for injured persons.



Rescue harness

Rescue harness or protective clothing with a loop sewn into the neck. During rescue, the rescue rope will be attached to the neck loop. Injured persons will be lifted out using a rescue lifting device with a self-actuating load brake.



Suitable working clothing

Leak-proof working clothing protects the skin from becoming soiled and from possible infections. Visually conspicuous working clothing makes the employee more visible to traffic.



Appropriate footwear

Safety footwear should, in particular, have good grip and be slip-resistant and leak-proof (e.g. rubber boots).



Gloves

Appropriate gloves will protect you from hand injuries and contact with materials that could impair your health and from untreated water.



Hardhat

The hardhat will protect your head from falling objects and from bumping into fixed components and objects.



Hearing protection

If there is noise that could damage your hearing, you can wear, e.g. earmuffs with built-in headphones and microphone.



Eye protection

Your eyes should be protected against slivers, sprayed dangerous substances, etc.



Lighting independent of the power grid

For example, you should carry a waterproof flashlight or wear a flashlight attached to your hardhat.

2.9 ⚠️ General safety instructions

Danger! | High-pressure water jets



Defects in or improper use of the product could cause hazards due to pressurized water spray. Ensure that the product is in perfect condition before operation. Highly concentrated water jets could cause severe injury and could even sever limbs. Noncompliance with these safety instructions can be **fatal** or could lead to severe injury.

Warning! | Falling objects



Dust particles and other loose particles are removed from the surface to be cleaned during high-pressure cleaning. These particles are accelerated to high speeds by the energy of the water jet, and can cause property damage and injuries. When conditions are unfavorable, for example, when working above your head, use protective equipment appropriate for this task. Noncompliance with these safety instructions can be **fatal** or could lead to severe injury.

Warning! | Risk of falling



You will be affected by a reaction force due to the high-pressure jet discharged. If you are working on scaffolding, protect yourself from falling. Falling from height can be **fatal** or could lead to severe injury.

Caution! | Sharp objects



If the product is tampered with, there is a risk of hand injuries due to sharp edges. Wear gloves during work. Pay attention to where you grip the product. If you do not do so, this could result in cutting injuries to your hands or other parts of your body.

Caution! | Trip hazard



Lines and other objects are to be expected on the ground in the area around where the product is being used. Pay attention to where you are walking. Keep the area of use tidy. Tripping and falling could cause injuries.

CAUTION!



Wear hearing protection. The water jet hitting the material will cause additional noise. Being exposed to noise can lead to hearing loss, tinnitus, or physiological disorders.



CAUTION!

The machines may not be used by children. Children must be watched to ensure that they do not play with the device.



CAUTION!

This machine may not be used by persons (including children) with impaired physical, sensory, or mental abilities or a lack of experience and knowledge.



CAUTION!

High-pressure hoses, valves, and couplings are important for machine safety. Only use high-pressure hoses, valves, and couplings that are recommended by the manufacturer.



CAUTION!

Water that has flowed through the backflow preventer is not drinkable.

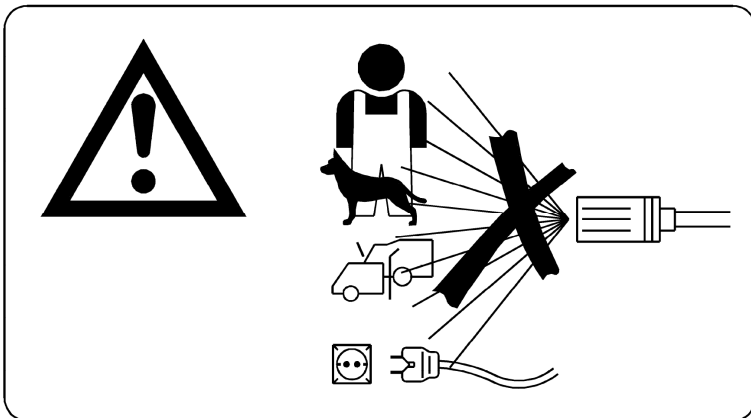

Figure 1: Warning SN EN 60335-2-79

3. Legal

3.1 Copyright

This manual shall not be duplicated partially or in its entirety without the prior written permission of **enz® technik ag**. It shall not be photocopied, reproduced, translated, or converted into an electronic or machine-readable format.

©2020 enz® technik ag, 6074 Giswil, Switzerland.
All rights reserved

3.2 Exclusion of liability

The manufacturer is not liable for damage that:

- Is caused as a result of unauthorized changes to the product.
- Is caused by not following the safety instructions.

3.3 Warranty conditions

In accordance with our sales and delivery conditions, we offer a warranty. However, the warranty is voided if:

- The product is used under conditions that are not permitted by us.
- Replacement and accessory parts that are not original replacement or accessory parts from **enz® technik ag** are used.
- If there is damage due to:
 - Improper use
 - Not following the operating instructions
 - Unsuitable operating equipment
 - Incorrect or improper routing of the hose or pipelines
 - Unauthorized changes or modifications to or conversions of the product

4. Environment

4.1 Disposal

Legacy equipment contains valuable recyclable materials that should be sent to a recycling center. Therefore, please dispose of legacy equipment at suitable collection points.

4.2 Environmental protection

Please note that surfaces are to be cleaned only if the composition is known. Under no circumstances may chemicals or other toxic substances be allowed to enter the environment. Do not use excessive amounts of water. This will help preserve our natural resources.

5. Spray guns

5.1 Introduction

enz® spray guns are universally usable surface cleaning devices. They can be configured individually to ensure the most efficient use possible. The spray guns are designed for temperatures of up to 150 °C.



Art. no.: 18.41
Name: SG-41



Art. no.: 18.42
Name: SG-42



Art. no.: 18.43
Name: SG-43



Art. no.: 18.44
Name: SG-44



Art. no.: 18.45
Name: SG-45

Figure 2: Overview of the spray guns

5.2 Application

The application is professional high-pressure cleaning (hot and cold water). The guns are intended only for applying liquids. This could be water or commercially available cleaning or disinfecting agents (liquids of Group II in accordance with 97/23/EC). The application areas include:

- Cleaning manholes
- General surface cleaning work
- General high-pressure cleaning work

5.3 Transport and storage

Ensure that the spray gun is protected from soiling during transport and storage. Protect the spray gun from frost. If exposed to frost, the spray gun can become seriously damaged, to the extent that flawless operation cannot be guaranteed.

5.4 Technical data

Article number	Total length [mm]	Weight [kg]	Connecting thread ["]	Swivel joint integrated	Temperature [°C]	Water jet	Jet nozzles	Recycled water	Max. flow rate [l/min]	Max. working pressure [bar]
18.41	950	1.2	1/2	Yes	5-150	Round or flat	1	No	45	300
18.42	1180	1.8	3/8	Yes	5-150	Round and flat	2	No	36	300
18.43	1100	2.1	1/2	Yes	5-150	Round or flat	1	Yes	200	350
18.44	1070	1.9	3/8	Yes	5-150	Round or flat	1	No	30	200
18.45	780	2.3	1/2	No	5-90	Round	1	Yes	45	250

Table 1: Technical data

Article number	Total length [yd]	Weight [kg]	Connecting thread ["]	Swivel joint integrated	Temperature [°C]	Water jet	Jet nozzles	Recycled water	Max. flow [US gpm]	Max. working pressure [psi]
18.41	1.04	1.2	1/2	Yes	5-150	Round or flat	1	No	12	4,350
18.42	1.29	1.8	3/8	Yes	5-150	Round and flat	2	No	10	4,350
18.43	1.20	2.1	1/2	Yes	5-150	Round or flat	1	Yes	53	5,000
18.44	1.17	1.9	3/8	Yes	5-150	Round or flat	1	No	8	2,900
18.45	0.85	2.3	1/2	No	5-90	Round	1	Yes	12	3,600

Table 2: Technical data for the US

5.5 Scope of supply

Art. no.	Standard equipment	Included
18.41	Ø 2.7 mm round jet	
18.42	Ø 1.7 mm flat jet Ø 1.7 mm round jet	Ø 2.7 mm round jet
18.43	Ø 3.2 mm round jet	Ø 4.0 mm round jet
18.44	Ø 1.3 mm round jet	Ø 2.1 mm round jet
18.45	Ø 3.0 mm round jet	

Table 3: Scope of supply

5.6 Flow table

Pres- sure	bar	20	40	60	80	100	120	140	160	180
	psi	290	580	870	1,160	1,450	1,740	2,030	2,320	2,610
Ø [mm]		Flow l/min and US gpm								
1.7		8.0	11.4	13.9	16.1	18.0	19.7	21.3	22.7	24.1
		2.1	3.0	3.7	4.2	4.7	5.2	5.6	6.0	6.4
2.0		11.4	16.1	19.7	22.8	25.5	27.9	30.1	32.2	34.2
		3.0	4.3	5.2	6.0	6.7	7.4	8.0	8.5	9.0
2.1		12.9	18.3	22.4	25.8	28.9	31.7	34.2	36.6	38.8
		3.4	4.8	5.9	6.8	7.6	8.4	9.0	9.7	10.2
2.7		20.2	28.5	34.9	40.3	45.1	49.4	53.3	57.0	60.5
		5.3	7.5	9.2	10.6	11.9	13.0	14.1	15.1	16.0
2.8		22.3	31.6	38.7	44.7	49.9	54.7	59.1	63.2	67.0
		5.9	8.3	10.2	11.8	13.2	14.5	15.6	16.7	17.7
3.0		25.6	36.3	44.4	51.3	57.3	62.8	67.8	72.5	76.9
		6.8	9.6	11.7	13.5	15.1	16.6	17.9	19.2	20.3
3.2		29.2	41.3	50.5	58.3	65.2	71.4	77.2	82.5	87.5
		7.9	11.2	13.8	15.9	17.8	19.5	21.0	22.5	23.8
4.0		45.6	64.5	78.9	91.2	101.9	111.6	120.6	128.9	136.7
		12.0	17.0	20.9	24.1	26.9	29.5	31.9	34.1	36.1
Pres- sure	bar	200	220	240	260	280	300	320	340	360
	psi	2,900	3,190	3,480	3,770	4,060	4,350	4,640	4,930	5,220
Ø [mm]		Flow l/min and US gpm								
1.7		25.4	26.7	27.9	29.0	30.1	31.1	32.2	33.1	34.1
		6.7	7.0	7.4	7.7	7.9	8.2	8.5	8.8	9.0
2.0		36.0	37.8	39.5	41.1	42.6	44.1	45.6	47.0	48.3
		9.5	10.0	10.4	10.9	11.3	11.7	12.0	12.4	12.8
2.1		40.9	42.9	44.8	46.6	48.4	50.1	51.7	53.3	54.8
		10.8	11.3	11.8	12.3	12.8	13.2	13.7	14.1	14.5
2.7		63.7	66.8	69.8	72.7	75.4	78.1	80.6	83.1	85.5
		16.8	17.7	18.4	19.2	19.9	20.6	21.3	22.0	22.6
2.8		70.6	74.1	77.4	80.5	83.6	86.5	89.3	92.1	94.7
		18.7	19.6	20.4	21.3	22.1	22.8	23.6	24.3	25.0
3.0		81.1	85.0	88.8	92.4	95.9	99.3	102.5	105.7	108.8
		21.4	22.5	23.5	24.4	25.3	26.2	27.1	27.9	28.7
3.2		92.2	96.7	101.0	105.2	109.1	113.0	116.7	120.3	123.8
		25.1	26.4	27.5	28.7	29.7	30.8	31.8	32.8	33.7
4.0		144.1	151.2	157.9	164.3	170.5	176.5	182.3	187.9	193.4
		38.1	39.9	41.7	43.4	45.1	46.6	48.2	49.6	51.1

Table 4: Flow table

5.7 Reaction forces

The water jet discharging at high pressure causes a reaction force. This can be so large that the spray gun can no longer be held securely. EU directives require the use of shoulder supports as mandatory when working with a reaction force of more than 150 N. If the reaction force is over 250 N, then hand-operated use is no longer permitted.

Figure 3 below shows two examples.

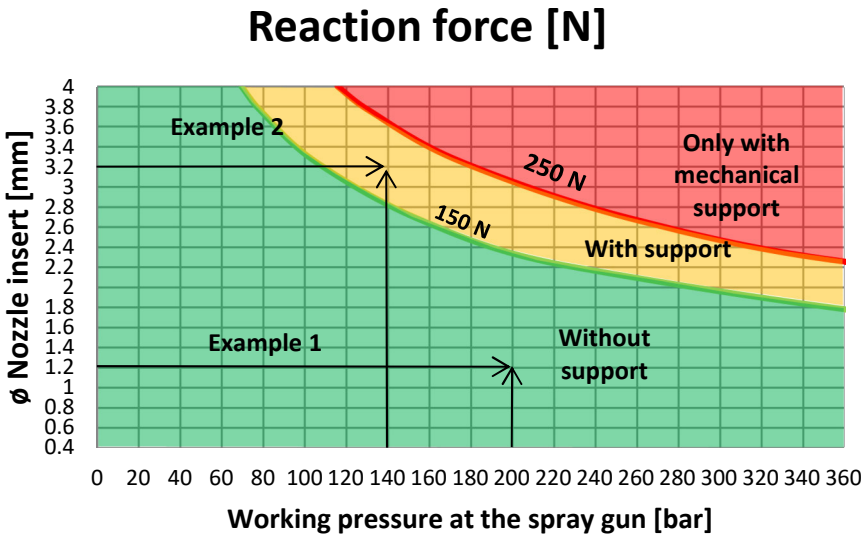

Figure 3: Reaction force with straight spray guns

Example 1: With a nozzle insert with \varnothing 1.2 mm and 200 bar working pressure, the reaction force is less than 150 N. Here, you do not need to take any additional measures.

Example 2: With a nozzle insert with \varnothing 3.0 mm and 140 bar working pressure, the reaction force is greater than 150 N. The spray gun must additionally be fitted with a shoulder support.



Determine the working pressure in [psi] based on the flow table on Page 17.

5.7.1 Reaction force for spray guns SG-41, SG-43, and SG-45



Figure 4: SG-41



Figure 5: SG-43



Figure 6: SG-45

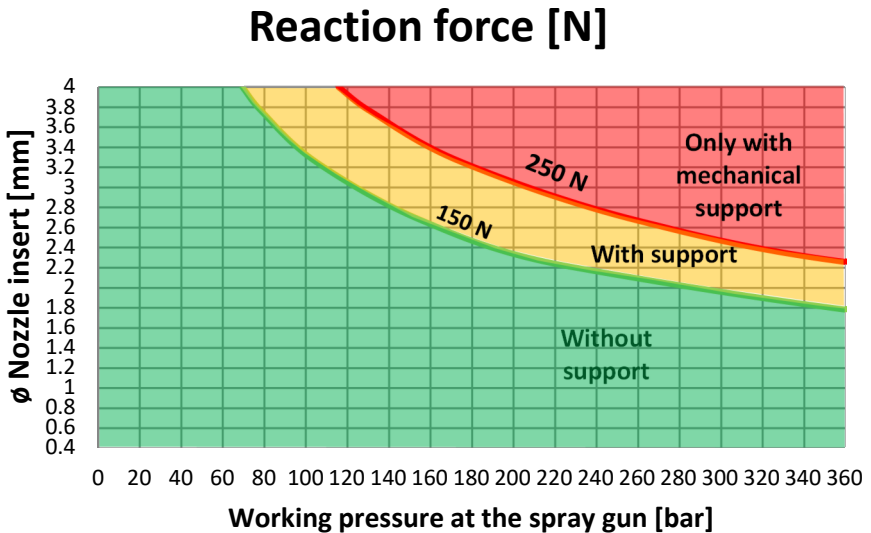

Figure 7: Reaction force with straight spray guns

5.8 Torques

The SG-42 and SG-44 spray guns have angled lances, which generate a torque. In accordance with DIN EN 60335, a maximum torque of 20 Nm is permissible on the spray gun grip. The user is more limited by this torque than by the reaction force. Therefore, with SG-42 and SG-44 spray guns, you must pay attention to the torque table.

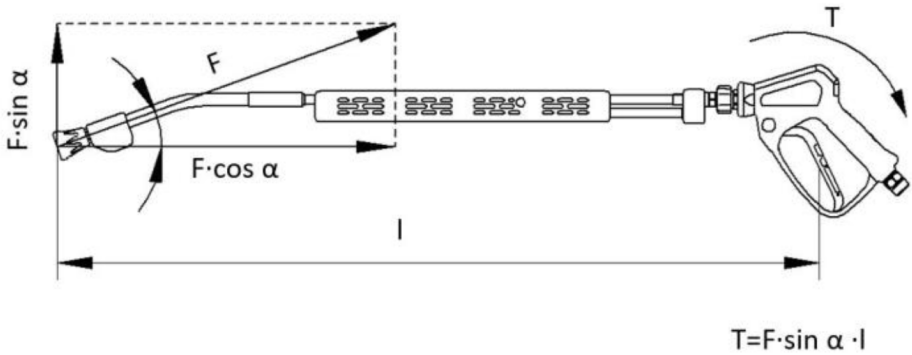

Figure 8: Torque calculation

5.8.1 Calculating the torque on the SG-42 grip

To calculate:

T = torque [Nm]

Given:

F = reaction force [N] = 70 N

l = length [m] = 1.05 m

$\sin \alpha$ = $\sin (15^\circ)$ = 0.259

$$T = F * \sin \alpha * l$$

$$T = 70 \text{ N} * 0.259 * 1.05 \text{ m}$$

$$T = 19.02 \text{ Nm}$$

5.8.2 SG-42 spray gun torque



Figure 9: SG-42

Max. torque with two active nozzles
20 Nm

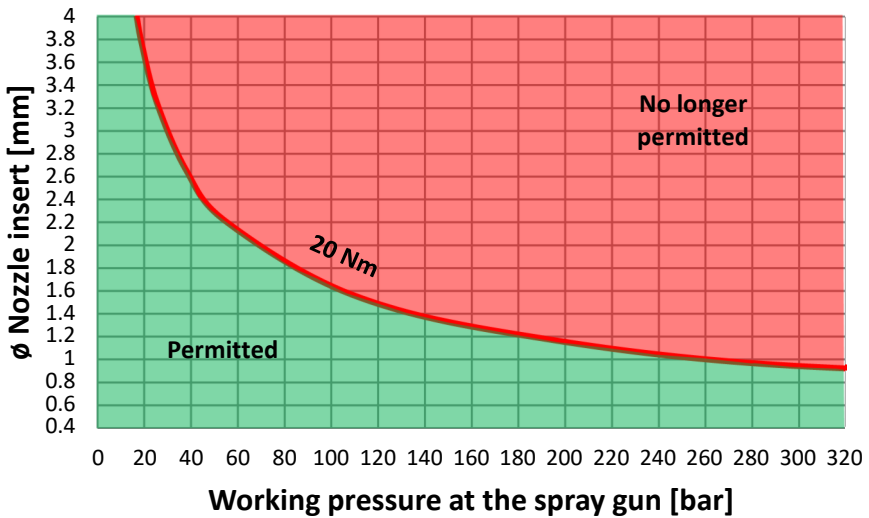

Figure 10: Torque SG-42 with two active nozzles



The SG-42 spray gun has a double lance. A round jet is mounted on the lower pipe connection. The flat jet nozzle mounted on the upper pipe connection can be turned on and off with a rotating movement on the hand grip.



CAUTION!

If the upper flat jet nozzle is switched on, the flow will increase, and therefore also the torque on the gun.

5.8.3 SG-44 spray gun torque



Figure 11: SG-44

Max. torque 20 Nm

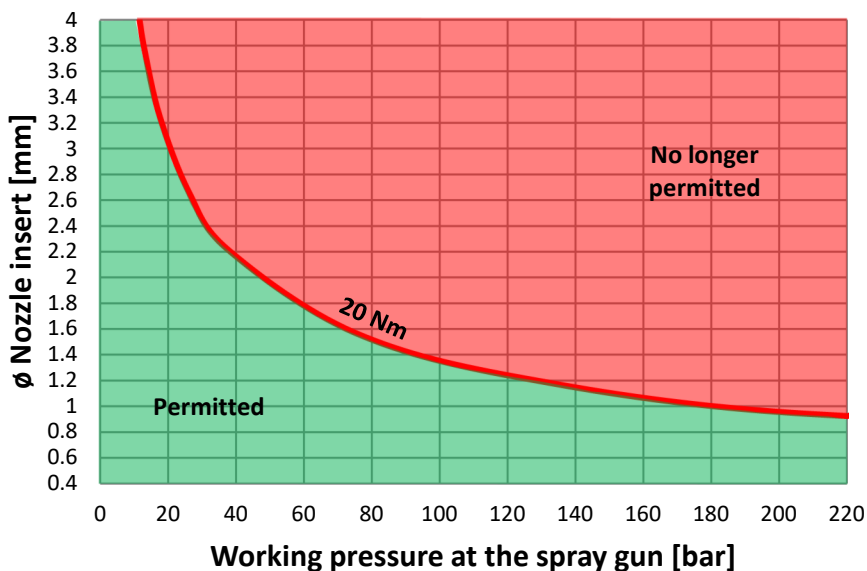

Figure 12: Torque for SG-44 at a 90° angle



The SG-44 spray gun has a "Push & Pull" lance, which can be angled up to 120° without set increments. To angle the lances, pull the hand grip backward. To align the lances straight, push the hand grip forward. Hold the grip on the "Push & Pull" lance securely, because otherwise the lance angle can change.



CAUTION!

Angling the "Push & Pull" lance increases the torque. Read all the information on working with the "Push & Pull" lance. Angle the lance only after you have actuated the trigger.

6. Installation

6.1 Assembly

The spray gun is delivered ready-to-operate. Use only high-pressure components (hoses, couplings, etc.) that are permitted for the respective pressure and temperature range. Use only replacement parts made by enz[®] technik ag.



SG-45 spray gun:

A swivel joint can be used for the connection between the high-pressure hose and the spray gun to ensure that the high-pressure hose does not become twisted.



To prevent blockages, install a fine dust filter in the water supply to the high-pressure generator (50 µm).

6.2 Setting up the work area

Prior to working with enz[®] spray guns, the following actions must be taken:



Set up barriers and safety equipment (warning triangle, block off the area, etc.).



Find out the necessary information about the object to be cleaned.



In containers and manholes:

Measuring instruments such as explosive gas meters, oxygen meters, gas warning devices, etc. must be readily available and used.



The work area must be blocked off and secured so that there is no risk of falling or danger caused by third parties.



Have the liability waiver signed to protect against any possible damage claims.

7. Operation

7.1 Operating the spray guns

Operate the spray gun only in the specified pressure, volume flow, and temperature range. Always check the values on the high-pressure generator each time before you begin work and adjust them if necessary.

The following points must be followed for proper use of the spray gun:

1. Hold the spray unit in your hand securely by the gripping surfaces provided for this purpose and ensure that you have a good footing.
2. To work with the spray gun, fold in the safety lock.
3. Actuate the trigger to open the valve in the spray gun.
4. Let go of the trigger to close the valve in the spray gun. The spray gun will remain under pressure.
5. To prevent accidental opening of the valve in the spray gun, fold out the safety lock.



Figure 13: Safety lock on the spray gun

**WARNING**

Do not point the outlet at yourself or other living creatures, and never reach into the discharging high-pressure jet. Manual intervention when the high-pressure generator is running could cause serious accidents.

**WARNING**

Do not use this machine near people unless they are wearing protective clothing.

**WARNING**

With short lances, there is an increased danger of injuring yourself on the water jet.

**CAUTION!**

Do not point the jet at yourself or others to clean clothing or shoes.

**CAUTION!**

Do not spray on any objects that contain substances that could be hazardous to health (such as asbestos), conduct electricity, or are fragile (such as glass).

**CAUTION!**

High-pressure jets can be dangerous if used improperly. The jet may not be pointed at people, live electrical equipment, or at the machine itself.

**CAUTION!**

Do not touch any bare surfaces on the spray gun if you are working with a liquid temperature of more than 40 °C.

**CAUTION!**

High-pressure cleaners may not be operated by children or untrained persons.

**CAUTION!**

To ensure the safety of the machine, use only original spare parts from the manufacturer or spare parts approved by the manufacturer.

**CAUTION!**

Do not leave the spray gun unattended if the high-pressure generator is switched on.



Switch the high-pressure generator off during work breaks. Then open the gun for a short period of time to release the pressure that is still present.



Prior to long periods of non-use (one hour or more), wash the gun thoroughly with water if you are using cleaning and disinfecting agents.

7.2 Replacing nozzle inserts

The nozzle inserts in every spray gun can be easily changed. To do so, go through the following steps.

1. Remove the plastic cover with a Phillips-head screwdriver. (Only the SG-44 spray gun).
2. Remove the nozzle with the appropriate socket wrench.
3. Remove any adhesive residue from the thread.
4. Coat the thread of the nozzle to be inserted with some Loctite 243.
5. Screw the nozzle in as far as it will go, then use a socket wrench to slightly tighten it (hand-tight).
6. Mount the plastic cover with a Phillips-head screwdriver. (Only the SG-44 spray gun).



Figure 14: Removing/mounting the plastic cover

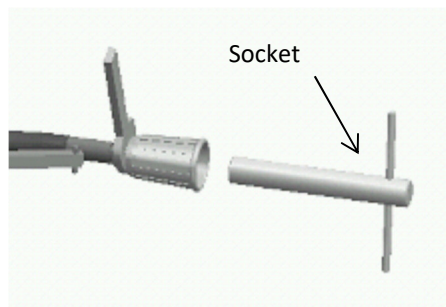

Figure 15: Replacing nozzle inserts



When releasing or tightening a nozzle on an SG-44 spray gun, secure it with an SW17 wrench to prevent any strain on the hose.

**CAUTION!**

Allow the Loctite 243 to harden for at least six hours to achieve an optimal result. Not observing the hardening period can lead to the adhesive being washed off by the water jet.

8. Maintenance

Maintenance and repair work may be performed only by persons who have been trained to do repairs on high-pressure systems. Use only accessories and spare parts that have been approved by enz® technik ag. Use only high-pressure components (hoses, couplings, etc.) that are permitted for the respective pressure and temperature range.

8.1 Inspections

Inspect the valve parts (seal seat, o-rings, support rings, ball, piston rod, pressure piece) after 1,000 operating hours or one year or, if using hot water (over 90 °C) or chemicals, after 500 operating hours or six months for damage and replace parts as necessary from the repair set (see 8.2).

8.2 Replacing the repair set

After 3,000 operating hours or three years or, with hot water (above 90 °C) or use of chemicals, after 1,500 operating hours or 18 months, replace the valve parts completely using the repair set.

1. Necessary tools:

- A, B, C, and D (in the repair set)
- Needle-nosed pliers and open-end wrench (not in repair set)

In repair set

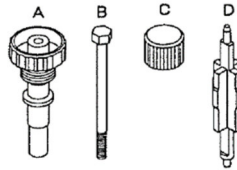

not in repair set

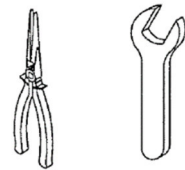

2. Remove gun cover.

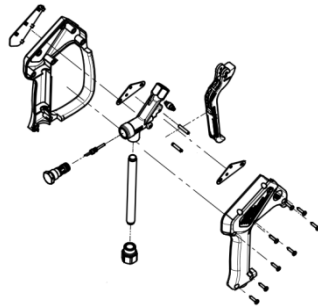

3. Unscrew item 1 from the housing. Then, pull the hand lever and pull items 3, 4, and 9 out with the needle-nosed pliers.

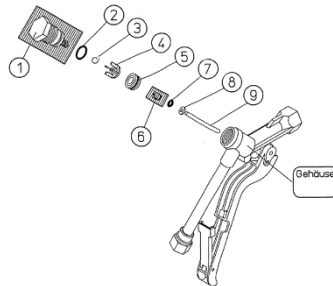

4. Screw tool A into the housing.

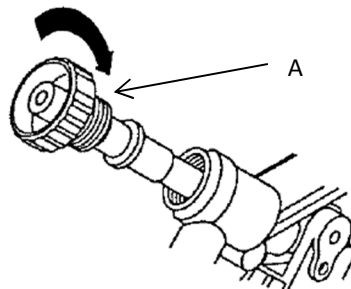

5. Insert B into A and screw it in completely with tool C.

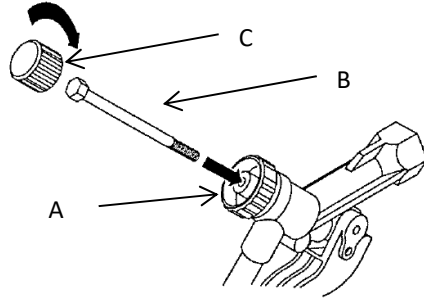

6. Unscrew tool A. Keep item 6 in a safe place for reinstallation. Replace items 4 and 5.

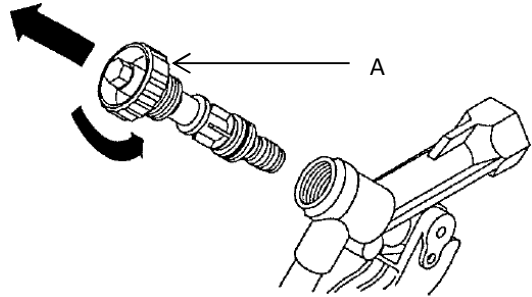

7. Press side Ø of tool D as far as possible into the housing and then pull it out. Then, remove items 7 and 8.

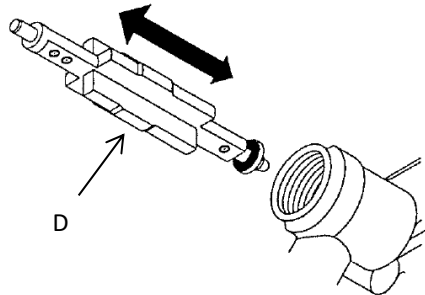

8. Installation and assembly are done in reverse order.

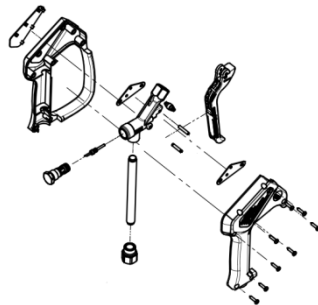

Figure 16: Changing the repair set

8.3 Cleaning

Clean the spray gun before long work breaks. To do so, actuate the gun for a short period of time to release the pressure that is still present. The high-pressure cleaner must be shut off when you do this. Use a fiber-free cleaning cloth to clean the exterior.

**CAUTION!**

Do not use any aggressive cleaning agents.



Insufficient cleaning of the spray gun can cause the nozzle to become clogged. After you have switched off the high-pressure generator, you can clear the blockage with a thin wire or similar.

9. Accessories/spare parts



9.1 Shoulder support

Shoulder support	Article number	Specifications	Weight
	0018.438	<ul style="list-style-type: none"> • Can be adjusted without set increments between 340 and 500 mm • Compatible with <ul style="list-style-type: none"> ○ 18.43 ○ 18.45 	0.80 kg



9.2 Swivel joints

Swivel joints	Article number	Specifications	Thread
	0018.050	<ul style="list-style-type: none"> • Compatible with <ul style="list-style-type: none"> ○ 18.45 	1/2"

9.3 Repair sets

Repair sets	Article number	Specifications
	0018.429	<ul style="list-style-type: none"> • Compatible with <ul style="list-style-type: none"> ○ 18.41 ○ 18.42 ○ 18.44
	0018.4599	<ul style="list-style-type: none"> • Compatible with <ul style="list-style-type: none"> ○ 18.45
	0018.439	<ul style="list-style-type: none"> • Compatible with <ul style="list-style-type: none"> ○ 18.43

9.4 Lance heads

Lance heads	Article number	Specifications	Thread
	08.0551	<ul style="list-style-type: none"> • Round jet \varnothing 5 mm • Compatible with <ul style="list-style-type: none"> ○ 18.43 	1/2"
	08.0501 round 08.0502 flat	<ul style="list-style-type: none"> • For M10 ceramic inserts • Compatible with <ul style="list-style-type: none"> ○ 18.43 	1/2"

9.5 Gun nozzles



9.5.1 SG-41, SG-42, and SG-44

Round jet 1/4"	Article number	Specifications	Thread
	22S025N13	Ø 1.3 mm	1/4"
	22S025N17	Ø 1.7 mm	1/4"
	22S025N21	Ø 2.1 mm	1/4"
	22S025N27	Ø 2.7 mm	1/4"

9.5.2 SG-42

Flat jet 1/4"	Article number	Specifications	Thread
	22S025N17F40	Ø 1.7 mm	1/4"

9.5.3 SG-43

Round jet M10	Article number	Specifications	Thread
	22.10	Ø 3.2 mm	M10
	22.10	Ø 4.0 mm	M10
Flat jet M10	Article number	Specifications	Thread
	22.10F	Ø 2.8 mm	M10

9.5.4 SG-45

Round jet M15x1	Article number	Specifications	Thread
	0018.4542	Ø 2.0 mm	M15x1
	0018.4543	Ø 3.0 mm	M15x1

10. Index

<i>Figure 1: Warning SN EN 60335-2-79</i>	11
<i>Figure 2: Overview of the spray guns</i>	14
<i>Table 1: Technical data</i>	15
<i>Table 2: Technical data for the US</i>	15
<i>Table 3: Scope of supply</i>	16
<i>Table 4: Flow table</i>	17
<i>Figure 3: Reaction force with straight spray guns</i>	18
<i>Figure 4: SG-41</i>	19
<i>Figure 5: SG-43</i>	19
<i>Figure 6: SG-45</i>	19
<i>Figure 7: Reaction force with straight spray guns</i>	19
<i>Figure 8: Torque calculation</i>	20
<i>Figure 9: SG-42</i>	21
<i>Figure 10: Torque SG-42 with two active nozzles</i>	21
<i>Figure 11: SG-44</i>	22
<i>Figure 12: Torque for SG-44 at a 90° angle</i>	22
<i>Figure 13: Safety lock on the spray gun</i>	24
<i>Figure 14: Removing/mounting the plastic cover</i>	27
<i>Figure 15: Replacing nozzle inserts</i>	27
<i>Figure 16: Changing the repair set</i>	30

11. Notes



enz® technik ag
Schwerzbachstrasse 10
CH-6074 Giswil / Switzerland
Phone +41 41 676 77 66
Fax +41 41 676 77 67
info@enz.com
www.enz.com