



Enz[®] Camera



210.080

Operating instructions
English
August 24 | Version 1.4



Table of Contents

Table of Contents	2
Preface	5
Purpose of the document	5
1 Introduction	6
1.1 Validity.....	6
1.2 Marking	6
1.3 General information	7
1.3.1 Language version	7
1.3.2 Copyright.....	7
1.3.3 Documentation maintenance and storage	7
1.3.4 Colour design	7
1.3.5 Area of application	7
1.3.6 Occupational safety	7
1.3.7 Maintenance	7
1.4 Target group	8
1.5 Meaning of the general safety instructions	8
1.6 Types of instructions in these operating instructions	8
1.6.1 Other symbols and marks	9
1.7 Applied Standards and Directives.....	9
1.8 Risk Assessment	9
1.9 EU Declaration of Conformity	10
1.10 UKCA Declaration of Conformity	10
2 Information on safety	11
2.1 Intended use.....	11
2.2 Non-intended use.....	11
2.3 Qualifications of the personnel	12
2.4 Fundamental safety rules.....	13
2.4.1 Rules and occupational safety	13
2.4.2 General obligation for inspection and maintenance	13
2.4.3 Modifications	13
2.4.4 Power supply.....	13
2.4.5 Spare parts	13
2.4.6 Personal protective equipment	14
2.4.7 Conduct in event of malfunction	14
2.5 Responsibilities.....	14
2.5.1 Responsibilities of the operating company.....	14
2.5.2 Responsibilities of the operating personnel	15
2.5.3 Responsibilities of the service / maintenance personnel	16
2.6 Safety instructions.....	16
2.6.1 General safety instructions	16
2.6.2 Section-related safety instructions	16

2.6.3	Embedded safety instructions	16
2.6.4	Statutory safety instructions	16
2.6.5	Consequences when disregarding the safety instructions.....	16
2.7	Product-specific dangers	17
3	Technical data	19
3.1	Enz® Camera	19
3.2	Enz® Charging station	19
4	System description.....	20
4.1	Overview of all components of the Enz® Camera system	20
4.2	Overview Enz® Camera.....	21
5	Startup.....	22
5.1	Switching the enz® Camera on	22
5.2	Setting up the Smart Device and enz® Camera	22
5.3	Installing the enz® Camera in the cleaning nozzle	22
6	Operation.....	23
6.1	Charging the enz® Camera	23
6.1.1	Procedure.....	23
6.2	Switching the enz® Camera on and off.....	24
6.3	Operation	24
7	Maintenance.....	25
7.1	Cleaning	25
7.2	Care	25
7.3	Storage	25
8	Troubleshooting.....	26
8.1	Status bar error	27
8.1.1	Status bar: “WiFi” red	27
8.1.2	Status bar: “Battery” red.....	27
8.1.3	Status bar: “Memory” red.....	27
8.1.4	Status bar: “Moisture content in the enz® Camera” red	27
8.2	Status LEDs	27
8.2.1	Orange status LED illuminates during operation	27
8.2.2	Blue status LED flashes.....	27
8.3	Other errors.....	28
8.3.1	Camera will not turn on	28
8.3.2	Camera does not respond/will not turn off.....	28
8.3.3	WiFi connection established but 10.0.0.1 cannot be accessed	28
8.3.4	Camera overheats	28
9	Repair	29
10	Decommissioning and disposal	29
11	Directory	30
11.1	Tables	30
11.2	Figures	30

Version	Revision	Date	Signature
1.0	created	Jun 20	dog/kla
1.1	Revised feedback loop	Jul 20	dog/kla
1.2	Reformulated	Dec 20	fkr
1.3	Adapted Art. Nr and naming	Jan 21	slu
1.4	Changes in commissioning, EU and UKCA declaration of conformity, changes in chapter 2.1 and new title image	Aug 24	

Preface

Dear customer

Thank you for the trust you have placed in us by the choice of our product. We would be more than pleased to receive any improvement suggestions and any constructive suggestions. We consider your cooperation as contribution to the optimum execution of our product and the corresponding documentation.

If you have any questions or suggestions, please contact our customer services directly:

enz® technik ag
Schwerzbachstrasse 10
CH-6074 Giswil / Switzerland

Tel. +41 41 676 77 66
Fax. +41 41 676 77 67
info@enz.com
www.enz.com

Person responsible for the documentation:
Simon Lutz (Business Development Manager)

Deviations resulting from product further developments as well as printing errors are reserved.

Purpose of the document

These operating instructions serve to use our product in a comprehensive sense according to its intended use, correctly, effectively and safely. The users are informed about the risks and misuse.



Important!

Before using the product for the first time, read these original operating instructions, handle accordingly and keep the document in a safe place for future reference.

Carefully read through the operating instructions before working with the camera. Make sure that it has been understood by all persons working with the product.

The operating instructions should be made available to the operating personnel at all times. If lost, a copy can be requested from your local dealer or direct from the manufacturer. The operating instructions can also be printed out online.

1 Introduction

1.1 Validity

These operating instructions are valid for the Enz® Camera System consisting of the following components:

Designation	Article number
Enz® Camera	210.080
Enz® Magnet	210.0801
Enz® Charging station	291.0801

Table 1: Validity of these operating instructions

1.2 Marking

The type plate is attached to the housing of the Enz® Camera.

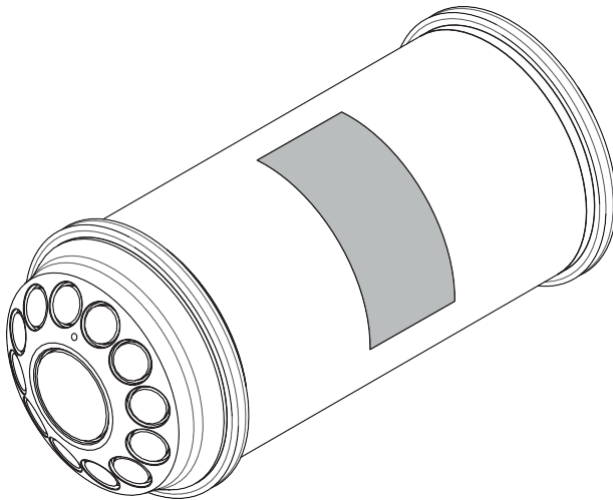

Figure 1: Type plate

1.3 General information

1.3.1 Language version

The original operating instructions are prepared in the German. All other languages are a translation of the original operating instructions. In case of doubt, information in the original operating instructions are decisive.

1.3.2 Copyright

All rights reserved. These operating instructions may neither be partially nor completely reproduced or converted in an electronically or machine-readable form without the written consent of Enz Technik AG.

1.3.3 Documentation maintenance and storage

To ensure that the operating instructions are complete and up to date at all times, please do not remove separate documents. Reorganise new supplemented documents immediately.

Keep the operating instructions at a location easily accessible near to the product.

1.3.4 Colour design

The operating instructions have colour coded warning instructions and may therefore only be used as coloured version.

1.3.5 Area of application

All persons who are authorised with setting up, operating, maintenance and transport of the product must carefully read and use the operating instructions.

1.3.6 Occupational safety

To ensure the occupational safety, the safety guidelines in these operating instructions must be observed.

Moreover, all regulations for the product concerning accident prevention as well as the generally recognised regulations for safe and correct working practices must be considered.

1.3.7 Maintenance

To ensure safety, operational capability and value retention of the product, the product must be maintained carefully and professionally.



Observe the instructions in the chapter Fehler! Verweisquelle konnte nicht gefunden werden. Fehler! Verweisquelle konnte nicht gefunden werden..

1.4 Target group

Target group	Tasks
Operating company (Sewer cleaning company)	<ul style="list-style-type: none"> Keep these operating instructions available at the operating location of the product, also for future use. Make sure that the personnel read and follow these operating instructions and the additionally applicable documents. Observe additional system-related provisions and regulations.
Operating personnel, service and maintenance personnel	<ul style="list-style-type: none"> Read and follow these operating instructions and the additionally applicable documents.

Table 2: Target group



Information about the necessary qualification of the personnel can be obtained in chapter **2.3 Qualifications of the** personnel.

1.5 Meaning of the general safety instructions

The general safety instructions inform you about potential residual risks which, despite correct use of the product.

To avoid personal injury, property or environmental damage, it is essential that all safety instructions are observed.

1.6 Types of instructions in these operating instructions

	DANGER!	Designates dangers which, if disregarded, will result in death or serious injuries!
	WARNING!	Designates dangers which, if disregarded, may result in death , severe injuries or invalidity!
	CAUTION!	Designates dangers which, if disregarded, may result in injuries and significant property, financial or environmental damage!



ATTENTION!

Designates a situation that may result in property damage, production downtimes or an environmental hazard.



This symbol marks important instructions for the safety-related and efficient use of the system.



Wear safety gloves.



Do not hold near to pace makers or implanted defibrillators!

1.6.1 Other symbols and marks

•	The dot refers to a listing or prerequisite for an action step.
1., 2., 3.,...	The clauses refer to a series of action steps.
✓	The check refers to the result of an action.

Table 3: Other symbols and marks

1.7 Applied Standards and Directives

The system described complies with the current status of technology and has been developed and manufactured in line with guidelines and standards according to EU Declaration of Conformity (see chapter **1.9 EU** Declaration of Conformity).

1.8 Risk Assessment

A risk assessment has been carried out for the system described in accordance with the Product Safety Act. The remaining residual risks are listed in these operating instructions.

1.9 EU Declaration of Conformity

enz Technik AG herewith declares that the enz® Camera complies with the requirements of the relevant directives of the EU:

- Low voltage directive 2014/35/EU
- Radio Equipment Directive 2014/53/EU (includes EMC Directive 2014/30/EU)

Email info@enz.com to request the full EU Declaration of Conformity.

1.10 UKCA Declaration of Conformity

enz Technik AG herewith declares that the enz® Camera complies with the requirements of the relevant directives of the UK:

- Radio Equipment Regulations 2017 (SI 2017 No. 1206, as amended by SI 2019 No. 696)
- Electromagnetic Compatibility Regulations 2016 (SI 2016 No. 1091, as amended)
- Electrical Equipment Safety Regulations 2016 (SI 2016 No. 1101, as amended)

Email info@enz.com to request the full UKCA Declaration of Conformity.

2 Information on safety

2.1 Intended use

The Enz[®] Camera System is determined for the following use and applications:

- The recording of videos and images during and after cleaning sewer and waste water pipes.
- The wireless transmission of the recordings to a digital end device (smartphone, tablet, PC).

Any other use or application beyond this shall be considered as non-intended use. The manufacturer cannot be held liable for damage resulting from this.

The following obligations belong to the intended use, amongst others:

- Observing all instructions in the operating instructions
- Carrying out all cleaning and maintenance work within the prescribed intervals as described in these operating instructions

2.2 Non-intended use



The claims for guarantee and liability are excluded if personal injury and property damage result from non-intended use.

- Mounting, commissioning, operation and maintenance without prior instruction.
- Operation with safety and protective equipment that are missing, incorrectly mounted or are non-functional.
- Operation, storage and transporting outside the limit values specified in the technical data and permissible ambient conditions according to chapter **3 Technical data**.
- Non-observance of instructions in the operating instructions with regard to transport, storage, assembly, commissioning, operation, maintenance and repairs.
- Rendering safety equipment ineffective and removal of warning signs.
- Operation of the product when persons are within a danger area.
- Conversions, modifications or changes carried out without written approval of the manufacturer.
- Operation in environments that require the use of ATEX certified equipment (2014/34/EU).
- Insufficient monitoring and / or maintenance of system components subject to wear.
- Improperly executed repairs.

- Use of the system by children.
- Use of impermissible Enz® Charging station.
- Operation if product safety is no longer guaranteed, e.g. catastrophic events (fire, flooding, lightning strike, etc.).

2.3 Qualifications of the personnel



Qualified personnel are persons that are authorised to carry out the respective necessary activities due to their education, experience and instruction as well as their knowledge about the relevant standards, directives and accident prevention regulations. Qualified personnel are also able to recognise and avoid possible hazards occurring during these activities in time.



All work with and on the product may only be carried out by qualified and trained personnel. The personnel must have read and understood the Enz® Camera operating instructions.

The operating company bears the responsibility for selection, instruction and training of the personnel as well as the ongoing monitoring of occupational safety.

WARNING!



Danger caused by insufficient qualification of persons.

- Have all work only carried out by persons qualified for this purpose.
 - Keep insufficiently qualified persons away from the work area.
 - Children and persons whose capability to react are impaired, e.g. by drugs, alcohol or medication may not remain in the vicinity of the product.
-

Depending on the activity, verification must be provided that the personnel have the following knowledge:

Person	Qualification
Operating personnel	<ul style="list-style-type: none"> • Training by the operating company • Knowledge of usual technical procedures of sewer and waste water cleaning.
Service and maintenance personnel	<ul style="list-style-type: none"> • Training by the operating company • Recognised professional-specific technical education (e.g. electronic professional education) • Knowledge of the relevant standards and provisions

Table 4: Qualifications of the personnel

2.4 Fundamental safety rules

2.4.1 Rules and occupational safety

- The local legislations as well as safety and accident prevention regulations apply for the operation of the product.
- Before putting into operation each time, all safety and protective equipment must be checked.
- Each working method which impairs safety must be avoided.
- During operation, only authorised personnel may remain in the operating area.
- All maintenance and repair work must only be carried out when the product is switched off and has cooled down. Before starting this work, the product must be secured against being switched on unintentionally.
- The operating company is responsible for the adherence and monitoring of the safety measures.

2.4.2 General obligation for inspection and maintenance

All notes for inspection and maintenance contained in these operating instructions must be observed.

2.4.3 Modifications

Modifications on the product with regard to attachments and conversions, use of non-original spare parts as well as software changes are prohibited.

2.4.4 Power supply

The connection values and tolerances for power supply as well as the power consumption specified are binding for the power connection (see chapter **3 Technical data**).

2.4.5 Spare parts

To ensure safe operation, only spare parts specified by the manufacturer may be used. Otherwise all guarantee and liability claims against the manufacturer become void.

2.4.6 Personal protective equipment

It is essential to use personal protective equipment if usage is prescribed as follows:

- by the operating instructions
- by the information signs
- by special work instructions of the operating company

The operating company must provide protective equipment to the personnel, issue respective instructions and check their execution.

The personnel must use the protective equipment as prescribed and are responsible for the storage and flawless state of the protective equipment.

2.4.7 Conduct in event of malfunction

If malfunctions cannot be remedied by the operating personnel using simple means, trained service and maintenance personnel or the Enz customer services must be consulted.

2.5 Responsibilities

2.5.1 Responsibilities of the operating company

The operating company has the following responsibilities:

- Intended use of the product according to chapter **2.1 Intended use**.
- Check that only authorised personnel work on the product:
 - the personnel must be familiar and trained in the fundamental regulations on occupational safety and accident prevention.
 - the personnel must have read and understood the operating instructions and confirmed this with their signature.
- Training and allocation of competences:
 - all persons working on the product will be provided with a thorough instruction, in particular in the residual risks and safety instructions based on the operating instructions.
- Instructions in event of dangers:
 - the operating company ensures that their personnel are informed about all existing residual risks and that work can only be carried out on the product based on these operating instructions.
 - the operating company ensures for the provision and maintenance of all auxiliary equipment and protective equipment relevant for safety, and mediates the necessary instructions for this purpose.
 - the operating company ensures for the marking of on-site danger areas (e.g. by floor markings, signs).
- Safety checks:

- the operating company performs regular checks for the safety-conscious working of the personnel.
- the operating company ensures that insufficient qualifications determined are eliminated by instructions and training courses.
- Maintenance and duty of care
 - the operating company ensures that the product is maintained and operated in a reliable operating state.
- Product registration and operating licence
 - the operating company ensures that a necessary registration is carried out with the authorities and offices at the location of the product and that all necessary operating licences are present.
 - the operating company ensures that legally stipulated inspections of the product or product components are carried out by technical experts in time.

2.5.2 Responsibilities of the operating personnel

The operating personnel have the following responsibilities:

- To read and understand the operating instructions
- Operation of the product only in an operational state
- Observe the fundamental regulations on occupational safety and accident prevention
- Check that during start-up and operation, no unauthorised persons remain at the product
- Report to supervisors immediately in case changes occur which impair safety
- Use and maintenance of the necessary protective equipment
- Cleanliness and clear arrangement in the vicinity of the product

2.5.3 Responsibilities of the service / maintenance personnel

The service / maintenance personnel have the following responsibilities:

- To read and understand the operating instructions
- Observe the fundamental regulations on occupational safety and accident prevention
- Correct maintenance and repairs of the product
- Check that during maintenance and repair work, no unauthorised persons remain at the product
- Use and maintenance of the necessary protective equipment
- Cleanliness and clear arrangement in the vicinity of the product

2.6 Safety instructions

2.6.1 General safety instructions

The general safety instructions in this chapter inform you about potential dangers which, despite correct use of the product, may be result or occur unexpectedly.

To avoid personal injury, property or environmental damage, it is essential that all persons working on product observe the safety instructions. For these persons, it is therefore particularly important that this chapter is read and understood.

2.6.2 Section-related safety instructions

The section-related safety instructions apply for the entire area of activity (e.g. operation, maintenance, etc.) and are listed at the beginning of each chapter.

2.6.3 Embedded safety instructions

The embedded safety instructions apply for certain situations within a handling instruction and are therefore listed at the relevant position affected.

2.6.4 Statutory safety instructions

The statutory regulations for accident prevention and environmental protection applicable at the operating location must be observed, as well as the recognised technical rules for safe and professional work.

2.6.5 Consequences when disregarding the safety instructions

Disregarding the safety instructions may lead to accidents with serious personal injury, property or environmental damage.

2.7 Product-specific dangers



WARNING!

Risk of injury from magnetic radiation of the Enz[®] Magnet!

Maintain a safety distance of the Enz[®] Magnet to pace makers and hearing aids:

- Pace maker: Distance at least 100 mm
- Hearing aid: Distance at least 30 mm



WARNING!

Risk of injury from electric shock or swallowing!

- Children could interpret Enz[®] Magnet as being a toy. Children may attempt to insert magnets into sockets. For this purpose, ensure that the Enz[®] Magnet cannot be accessed by children!



WARNING!

Risk of injury from contact with magnet surfaces containing nickel!

- Avoid permanent skin contact with the magnet on the Enz[®] Magnet.
- Persons with nickel allergy: do without using the Enz[®] Magnet.



CAUTION!

Risk of injury from aggressive sewer fluids!

- Before using the Enz[®] Camera each time, touch only with protective gloves and clean correctly.



CAUTION!

Risk of being blinded and risk of injury from LED radiation!

- During the start-up, cover the LEDs if the Enz[®] Camera is operated outside a sewer pipe.
- Do not look directly into the LEDs of the Enz[®] Camera.



ATTENTION!

Damage to the camera lens and LEDs!

- Before using each time, check the camera lens and LEDs for damage.
- Do not use the Enz[®] Camera with damaged camera lens or other external visual damage.

ATTENTION!**Damage to the sealing ring or diaphragm!**

- With externally visible damage to the sealing ring or diaphragm, do not use the Enz® Camera (see chapter **4.2 Overview Enz® Camera**).
- If the ingress of water can already be recognised, switch off the Enz® Camera immediately and no longer use it (see chapter **6 Operation**).
-). Contact Enz® customer services.

ATTENTION!**Damage to the Enz® Camera caused by incorrect handling of the charger!**

- During the charging process on the Enz® Charging station, switch off the Enz® Camera.
- Use only the supplied Enz® Charging station for charging the Enz® Camera.

ATTENTION!**Damage to the Enz® Camera from being used outside the defined temperature range!**

- Observe the permitted temperature range (see chapter **3 Technical data**).
- Never leave the Enz® Camera exposed to direct sunlight in a vehicle.

ATTENTION!**Damage to devices and objects caused by the magnetic field of the Enz® Magnet!**

- Keep the Enz® Magnet away from all devices and objects that could be damaged by strong magnetic fields (e.g. electronic devices, etc.).

3 Technical data

3.1 Enz® Camera

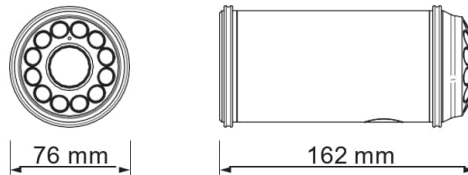

Figure 2: Dimensions

Criterion	Value
Weight	790 g
Rechargeable battery time	approx. 8 h
Rechargeable battery charge time	80% capacity after 3 h
Operating conditions:	
<ul style="list-style-type: none"> • Temperature range • Relative humidity • Ambient pressure 	-5 °C to +40 °C up to 100% 500-1060 mbar
Storage conditions:	
<ul style="list-style-type: none"> • Temperature range • Relative humidity • Ambient pressure 	-20 °C to +40 °C max. 60% 900-1060 mbar

Table 5: Technical data Enz® Camera

3.2 Enz® Charging station

Criterion	Value
Supply voltage	Input: 100-240 V AC, 50 / 60 Hz, max. 0,6 A Output: 15 V DC, 1.5 A
Protection category (water, dust)	No IP protection: For this purpose, before charging, always ensure that the Enz® Camera has been completely cleaned and dried.
Operating conditions:	
<ul style="list-style-type: none"> • Temperature range • Relative humidity • Ambient pressure 	+10 °C to +45 °C 30-60% 800-1060 mbar
Storage conditions:	
<ul style="list-style-type: none"> • Temperature range • Relative humidity • Ambient pressure 	-20 °C to +85 °C max. 85% 600-1060 mbar

Table 6: Technical data Enz® Charging station

4 System description

The Enz® Camera can be used to produce, process and save video recordings. Operation of the Enz® Camera and downloading the videos is carried out via remote client which will be installed on the smartphone / tablet. The connection between the Enz® Camera and remote client is carried out using WiFi technology.

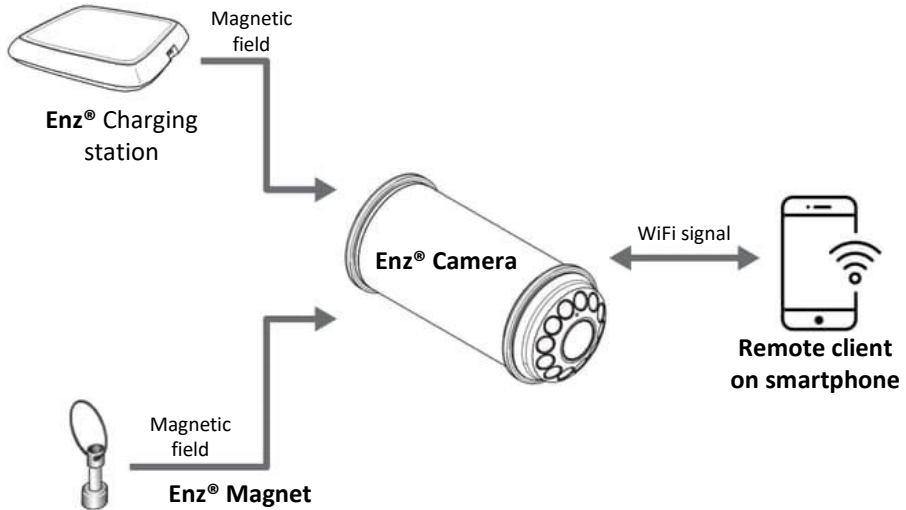

Figure 3: System description

4.1 Overview of all components of the Enz® Camera system

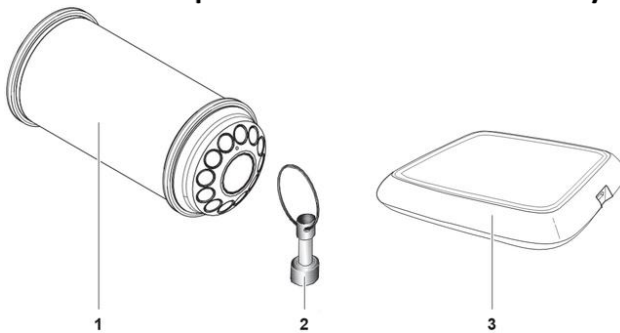

Figure 4: Overview of components

Pos.	Designation	Function
1	Enz® Camera	Camera module for video recording
2	Enz® Magnet	Switching the Enz® Camera on and off
3	Enz® Charging station incl. cable	Wireless charging of the Enz® Camera

Table 7: Overview of all components

4.2 Overview Enz® Camera

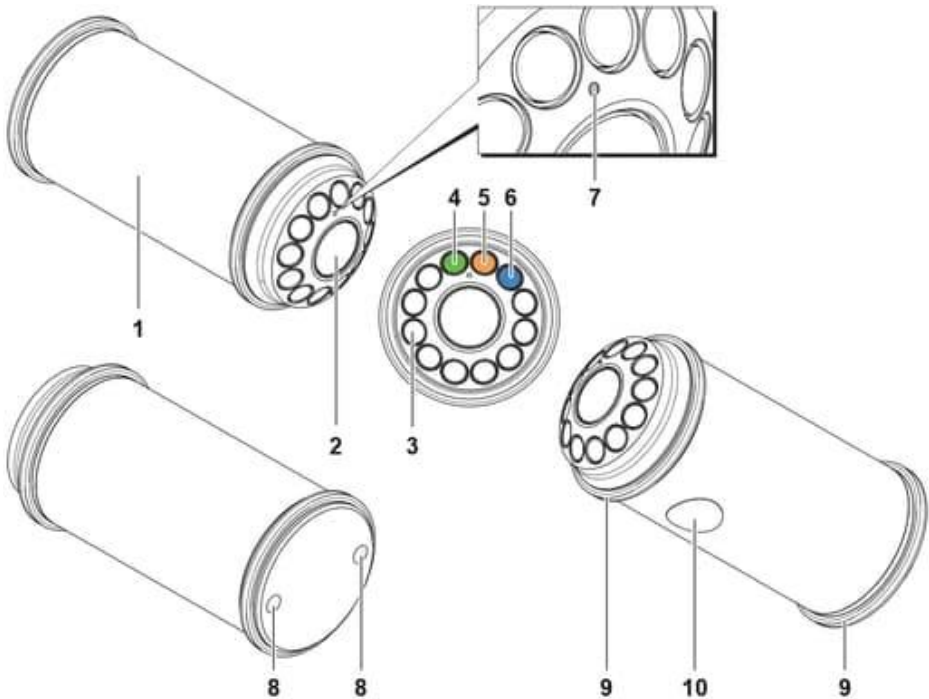

Figure 5: Overview Enz® Camera

Pos.	Designation
1	Housing
2	Camera lens made of robust sapphire glass
3	Illuminating LEDs (12 pieces, white)
4	Status LED, green: Enz® Camera switched on
5	Status LED, orange: <ul style="list-style-type: none"> • During operation: rechargeable battery almost empty • During charging: rechargeable battery charging process running
6	Status LED, blue: <ul style="list-style-type: none"> • During operation: flashing signal error or rechargeable battery charge state too low for video recording • During charging: rechargeable battery fully charged
7	Activation field for Enz® Magnet (switching on and off)
8	Fastening screw (ATTENTION: Never open!)
9	Rubber ring for vibration damping
10	Diaphragm for pressure compensation (ATTENTION: Do not damage)

Table 8: Overview Enz® Camera

5 Startup

5.1 Switching the enz[®] Camera on

Hold the magnetic key over the activation field for at least 2 seconds (see Section [4.2 Overview Enz[®] Camera](#)) and then remove it.



CAUTION

All 12 LEDs flash brightly when the enz[®] Camera is switched on.

- Do not look directly into the LEDs.

- ✓ All 12 LEDs flash twice.
- ✓ The green status LED illuminates and the enz[®] Camera is on.

5.2 Setting up the Smart Device and enz[®] Camera

Follow the included instructions “Apple iOS – Quick-Start Guide” or “Android – Quick-Start Guide.”

All instructions and instructional videos are available at www.enz.com.

5.3 Installing the enz[®] Camera in the cleaning nozzle

Follow the instructions on the info sheet sent with your cleaning nozzle.

6 Operation

6.1 Charging the enz[®] Camera

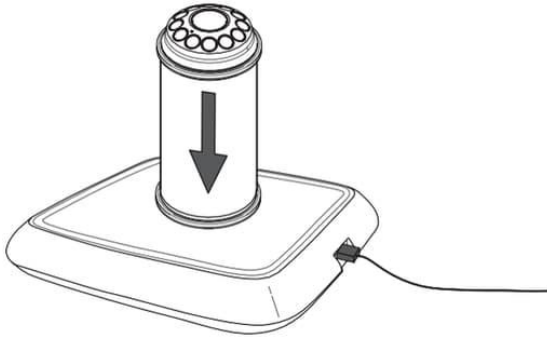

Figure 6: Charging the enz[®] Camera

6.1.1 Procedure

1. Plug the enz[®] charging station into a power source.
2. Set the back of the enz[®] Camera on the charging station.



Notice

Damage to the enz[®] charging station from dirt and moisture

- The enz[®] charging station is not dust proof or moisture proof. Clean and dry the enz[®] Camera before charging.

- ✓ Charging is in progress when the orange status LED is on.
- ✓ Charging is complete (battery fully charged) when the blue status LED is on.

6.2 Switching the enz[®] Camera on and off

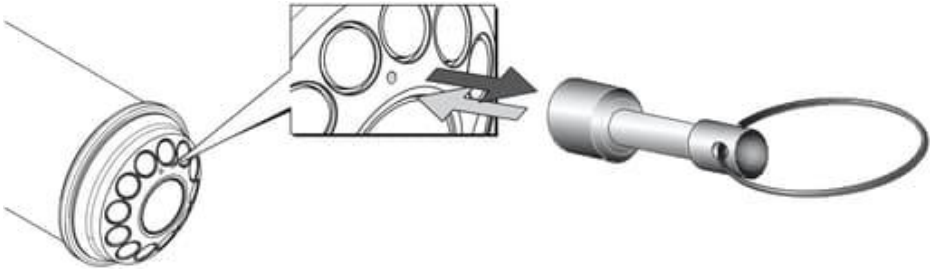

Figure 7: Switching the Enz[®] Camera on and off

- Switching on:** Hold the magnetic key over the activation field for at least 2 seconds.
- ✓ The lighting LEDs flash twice, and the green Status LED illuminates.
- Switching off:** Hold the magnetic key over the activation field for at least 2 seconds.
- ✓ The green status LED goes out, and the enz[®] Camera is off.
- Emergency shutdown:** Hold the magnetic key over the activation field for 25 seconds.
- ✓ The green status LED goes out, and the enz[®] Camera is off.



CAUTION

All 12 LEDs flash brightly when the enz[®] Camera is switched on.

- Do not look directly into the LEDs.

6.3 Operation

Follow the instructions in “Quick Start Guide – iOS and Android.”

All instructions and instructional videos are available at www.enz.com.

7 Maintenance

7.1 Cleaning

**CAUTION!****Risk of injury from aggressive sewer fluids!**

- Before using the Enz® Camera each time, touch only with protective gloves and clean correctly.

Clean the Enz® Camera after each use. Remove dirt deposits, in particular on the camera lens using conventional cleaning agent.

Before the next use, check the camera for damage to the housing, pressure-equalizing diaphragm, camera head, or sapphire glass.

7.2 Care

Recommendation for optimal image quality: Clean and treat the lenses with lens cleaner (C290) and lens polish (C291) daily.

7.3 Storage

Store the enz® Camera in the supplied case. Ensure that all items stored in the case are clean and dry before use.

8 Troubleshooting



All error messages are displayed in the status bar on the remote client. During troubleshooting, also observe the instructions in the safety chapter (see chapter **2.6 Safety** instructions).



Figure 8: Remote client status bar

In the following table, the error messages are apparent on the remote client. Different states are allocated with different icon colours. Remedy measures follow for error messages that occur.



















Symbol	Status		
 WiFi		 OK	
 Battery	 No WiFi	 OK	 Low battery charge
 Memory	 No WiFi	 OK	 Low free memory
 Camera status	 No WiFi	 OK	 Camera does not respond
 Moisture content in the Enz® Camera	 No WiFi	 OK	 Moisture content too high

Table 9: Overview of error messages



If an error message is active, video recording cannot be started!

8.1 Status bar error

8.1.1 Status bar: "WiFi" red

- Ensure that the enz[®] Camera is in range (< 2 meters).
- Ensure that the enz[®] Camera is properly installed in the cleaning nozzle. Ensure that the cleaning nozzle and accessories are properly assembled.
- Access the WiFi settings of your smart device and check if you are connected to a different WiFi option. Reconnect to the WiFi option "enz Camera."

8.1.2 Status bar: "Battery" red

- Switch off the enz[®] Camera and charge it on the charging station.

8.1.3 Status bar: "Memory" red

- Delete videos from the enz[®] Camera to free up memory.

8.1.4 Status bar: "Moisture content in the enz[®] Camera" red

- Switch off the enz[®] Camera.
- Check the enz[®] Camera for damage to the
 - housing
 - sapphire glass
 - pressure-equalizing diaphragm
- Switch the enz[®] Camera back on.
 - Contact enz[®] customer service if the error message appears again.

8.2 Status LEDs

8.2.1 Orange status LED illuminates during operation

- Switch off the enz[®] Camera and charge it on the charging station.

8.2.2 Blue status LED flashes

- Switch off the enz[®] Camera and charge it on the charging station.
- Check the status bar symbol after charging. Follow further troubleshooting instructions as applicable.

8.3 Other errors

8.3.1 Camera will not turn on

- Charge the enz[®] Camera on the charging station.
- Hold the enz[®] Magnet on the activation field, parallel to the lighting glass, for at least 4 seconds.

8.3.2 Camera does not respond/will not turn off

- Hold the enz[®] Magnet over the activation field, parallel to the lighting glass, for at least 30 seconds, waiting until the green LED goes out.

8.3.3 WiFi connection established but 10.0.0.1 cannot be accessed

- Ensure that the enz[®] Camera is in range (< 2 meters).
- Download the browser Google Chrome and try to access 10.0.0.1.

If the problem persists-----

- Open the cellular data settings on your smart device and deactivate cellular data.
- Try to access 10.0.0.1.

If the problem persists-----

- Open the WiFi settings on your smart device.
- Remove the WiFi option “enz Camera” (e.g., “ignore this network”).
- Reconnect to the WiFi option “enz Camera.”
- IMPORTANT: If your device asks if the WiFi connection should be maintained even though there is no internet connection, click “Yes, maintain this connection.”

If the problem persists-----

- Contact technical support.

8.3.4 Camera overheats

Immediately switch off the enz[®] Camera and contact enz[®] customer service.



CAUTION

If you believe that the battery in your enz[®] Camera might be defective (e.g., camera is misshapen or overheats), shipping via air freight is **PROHIBITED**.

In this case, please contact technical support.

9 Repair



The Enz® Camera may only be repaired by an authorised service technician. Contact the Enz® customer services for this purpose.

ATTENTION!



Risk of damage from improper repair!

- Never open the fastening screws (1) on the housing.
- Make sure that the sensitive diaphragm (2) is not damaged.
- **If disregarded, all claims for guarantee are void without exception!**

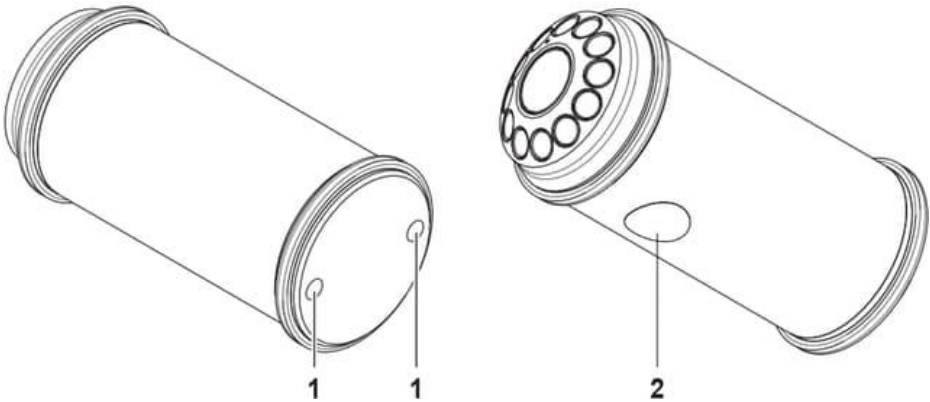

Figure 9: Camera repair

10 Decommissioning and disposal

WARNING!



Danger to the environment from incorrect disposal!

- All operating materials and auxiliary equipment such as seals, etc. must be disposed of according to the country-specific laws and guidelines of the company location
- Dispose of product components according to the country-specific laws and guidelines of the company location
- Incorrect disposal of operating materials, product components or parts thereof (e.g. in water, domestic waste, etc.) is strictly forbidden.

11 Directory

11.1 Tables

Table 1: Validity of these operating instructions6

Table 2: Target group.....8

Table 3: Other symbols and marks.....9

Table 4: Qualifications of the personnel13

Table 5: Technical data Enz® Camera19

Table 6: Technical data Enz® Charging station19

Table 7: Overview of all components20

Table 8: Overview Enz® Camera.....21

Table 9: Overview of error messages.....26

11.2 Figures

Figure 1: Type plate.....6

Figure 2: Dimensions.....19

Figure 3: System description20

Figure 4: Overview of components20

Figure 5: Overview Enz® Camera21

Figure 6: Charging the enz® Camera.....23

Figure 7: Switching the Enz® Camera on and off24

Figure 8: Remote client status bar26

Figure 9: Camera repair29



enz® technik ag
Schwerzbachstrasse 10
6074 Giswil, Switzerland
Phone +41 41 676 77 66
Fax +41 41 676 77 67
info@enz.com
www.enz.com