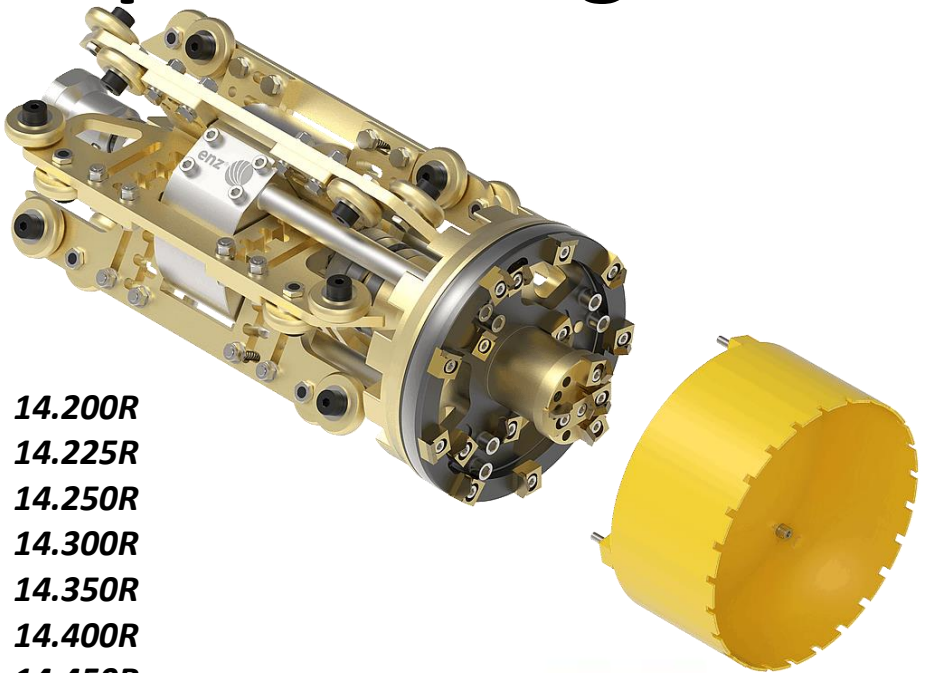




# IMC Recycling Impact milling cutter



**14.200R**  
**14.225R**  
**14.250R**  
**14.300R**  
**14.350R**  
**14.400R**  
**14.450R**

**Operating Manual**  
**English**  
**April 24 | Version 2.3**



# Table of Contents

<b>Table of Contents .....</b>	<b>2</b>
<b>Preface .....</b>	<b>5</b>
<b>Purpose of the document .....</b>	<b>5</b>
<b>1    ⚠ Safety .....</b>	<b>6</b>
1.1    ⚠ Consequences when disregarding the safety instructions .....	6
1.2    ⚠ Target group .....	6
1.3    ⚠ Requirements on the user .....	6
1.4    ⚠ Meaning of the general safety instructions .....	7
1.5    ⚠ Types of instructions in these operating instructions .....	7
1.6    ⚠ Intended use.....	8
1.7    ⚠ Safety instructions for modifications .....	8
1.8    ⚠ Protective equipment when working in shafts, pits and channels.....	9
1.9    ⚠ General safety instructions .....	11
<b>2    Rights.....</b>	<b>13</b>
2.1    Copyright .....	13
2.2    Disclaimer .....	13
2.3    Guarantee conditions .....	13
<b>3    Environment .....</b>	<b>14</b>
3.1    Disposal .....	14
3.2    Environmental protection .....	14
<b>4    Technical data .....</b>	<b>15</b>
4.1    Introduction.....	15
4.2    Area of application .....	15
4.3    Designation of the parts .....	15
4.4    Legend for technical data .....	16
4.5    14.2xxR .....	17
4.6    14.3xxR .....	17
4.7    14.4xxR .....	19
4.8    Tightening torques of the screws .....	20
<b>5    Cutting teeth.....</b>	<b>23</b>
5.1    Overview of cutting teeth .....	23
5.2    Cutting teeth on the centre cap .....	24
5.3    Cutting teeth on the inner ring.....	24
5.4    Cutting teeth on the outer ring .....	25
5.5    Equipping for calcareous deposits.....	27
5.6    Wood and plastic deposits .....	30
5.7    Equipping for concrete deposits.....	33
5.8    Teeth position overview .....	36
<b>6    Installation.....</b>	<b>37</b>

6.1	Equipping.....	37
6.2	Assembly of the tools .....	37
6.3	Preparation work.....	37
6.4	Setting up the workplace.....	38
6.5	Concluding work.....	38
<b>7</b>	<b>Operation.....</b>	<b>39</b>
7.1	Operating principle.....	39
7.2	Nozzle inserts .....	39
7.3	Operating the tool against the direction of flow .....	40
7.4	Operating the tool in the direction of flow .....	41
7.5	Cutting in plastic pipes .....	42
7.6	Milling in a slightly damaged pipe .....	43
7.7	Milling with diamond crown.....	43
7.8	After use .....	45
7.9	Disassemble the centre cap.....	45
7.10	Mount the centre cap.....	46
7.11	Mount the pull rod .....	47
7.12	Converting the recycling impact milling cutter (to another diameter) .....	48
7.13	Switch the impact off and on .....	50
7.14	Malfunctions.....	52
<b>8</b>	<b>Maintenance.....</b>	<b>53</b>
8.1	Changing the nozzle inserts.....	53
8.2	Changing the nozzle inserts.....	53
8.3	Changing the cutting tooth.....	55
8.4	Change the cam plates .....	56
8.5	Change the aluminium-bronze washer .....	58
8.6	Care .....	59
8.7	Storage .....	59
<b>9</b>	<b>Spare parts / Accessories .....</b>	<b>60</b>
9.1	14.200R-14.250R .....	60
9.2	14.300R-14.450R .....	62
9.3	Accessories .....	65
<b>10</b>	<b>Directory.....</b>	<b>70</b>
10.1	Tables .....	70
10.2	Figures .....	71
10.3	Drawings.....	71
<b>11</b>	<b>Annex.....</b>	<b>72</b>
11.1	Exclusion of liability .....	72
11.2	Milling project .....	73
11.3	Milling project check list.....	74
<b>12</b>	<b>Notes .....</b>	<b>75</b>

<b>Version</b>	<b>Revision</b>	<b>Date</b>	<b>Signature</b>
1.0	created	December 2015	ser
1.1	revised	September 2016	mre
1.2	revised	December 2018	hbu
2.0	revised and reformulated	January 2021	fkr
2.1	High performance grease Germes 101	July 2022	rri
2.2	14.400R & 14.450R added	September 2022	smu
2.3	Revised	February	awo

## Preface

### Dear customer

Thank you for the trust you have placed in us by the choice of our product. We would be more than pleased to receive any improvement suggestions and any constructive suggestions. We consider your cooperation as contribution to the optimum execution of our product and the corresponding documentation.

If you have any questions or suggestions, please contact our customer services directly:

**enz® technik ag**  
Schwerzbachstrasse 10  
CH-6074 Giswil / Switzerland

Tel. +41 41 676 77 66  
Fax. +41 41 676 77 67  
info@enz.com  
www.enz.com

Person responsible for the documentation:  
Bryan Bieri (Tech. Support / Head of QM)

Changes and enhancements due to technical progress as well as print errors are reserved.

## Purpose of the document

These operating instructions serve to use our product in a comprehensive sense according to its intended use, correctly, effectively and safely. The users are informed about the risks, reasonably foreseeable misuse and residual risks.



### Important!

Before using the product for the first time, read these original operating instructions, handle accordingly and keep them in a safe place for future reference.

---

Carefully read through the operating instructions before working with the cleaning tool. Make sure that it has been understood by all persons working with the product.

The operating instructions should be made available to the operating personnel at all times. It must be stored at an easily accessible location.

If the operating instructions are lost or have been destroyed, a copy can be requested from your local dealer or direct from the manufacturer.

# 1 Safety

## 1.1 Consequences when disregarding the safety instructions

Disregarding the safety instructions may lead to accidents with serious personal injury, property or environmental damage.


The manufacturer is not liable for damage that results from disregarding the safety instructions.

## 1.2 Target group

These operating instructions are intended for all persons that are involved in assembly, commissioning and operation of the pipe cleaning tool.

## 1.3 Requirements on the user

All persons that are involved in the assembly, commissioning and operation of the tool must ...

- be familiar with the cleaning work environment and have professional knowledge;
- be trained and instructed accordingly for the use of the product;
- have read and understood the operating instructions, in particular the chapter  **Safety**.

If the personnel do not have the necessary knowledge, this must be trained and instructed. If necessary, this can be carried out by the manufacturer of the pipe cleaning tool.

Only the maintenance and repair activities described in these operating instructions may be carried out by users who fulfil the requirements specified. All other maintenance and repair work may only be carried out by qualified personnel of the manufacturer.



Observe the instructions in the chapter "**Maintenance**".





---

### 1.4 ⚠ Meaning of the general safety instructions

The general safety instructions in this chapter inform you about potential residual risks which, despite correct use of the product, may be permanently present or occur unexpectedly.













To avoid personal injury, property or environmental damage, it is essential that all persons working with the product observe the safety instructions. For these persons, it is therefore mandatory that this chapter is read and understood.

### 1.5 ⚠ Types of instructions in these operating instructions

	<b>DANGER!</b>
Designates dangers which, if disregarded, will result in <b>death</b> or severe injuries!	
	<b>WARNING!</b>
Designates dangers which, if disregarded, may result in <b>death</b> , severe injuries and / or invalidity!	
	<b>CAUTION!</b>
Designates dangers which, if disregarded, may result in injuries and significant property, financial or environmental damage!	
	Information for the technically correct and efficient use of the product.

## 1.6 Intended use

Due to the high pressures and temperatures, there is a risk of property damage as well as a risk of injury for the user and other persons. For the correct and intended use of the product, the following points must be observed:

-  The pipe cleaning tool may be used exclusively in pipes or pipe-like channels. In doing so, the profile to be cleaned must be closed and surrounded by material.
-  The product is suitable for use in cast steel, concrete and plastic pipes.
-  The product may only be operated with correct hose connections free of faults.
-  During operation including setup and clearing work, the cleaning area (shaft, feed, etc.) must be sufficiently secured.
-  During operation, **no** persons may remain in the pipes or at the ends of the pipes.
-  The max. pressure specified on the nozzle may **not** be exceeded.
-  The dirty water may **not** be directed into streams or rivers.
-  Before putting into operation each time, the correct state of the product must be checked.
-  Defects must be rectified before putting into operation.
-  Use only a correct tool. (For nuts, use only matching spanners)
-  Secure hose lines in such a way that they cannot be damaged during operation.
-  Only accessory parts provided and approved by **enz® technik ag** may be used.

## 1.7 Safety instructions for modifications

It is forbidden to carry out any conversions or modifications to the pipe cleaning tool. Only parts authorised by the manufacturer may be used. The manufacturer is not liable for damage that results in conjunction with conversions to the product made at your own authority.



**1.8 ⚠ Protective equipment when working in shafts, pits and channels**

The employer provides suitable protective equipment. They must ensure that their employees wear these during work.

The protective equipment prescribed by the SUVA (Switzerland) are described in the following.

See the leaflet for this purpose:

**Safe access and working in shafts, pits and channels**

**Order number: 44062.d**

Suva  
 Schweizerische Unfallversicherungsanstalt  
 Arbeitssicherheit  
 Postfach, 6002 Luzern, Switzerland  
 Information:  
 Tel. 041 419 51 11  
 Orders:  
[www.suva.ch/waswo](http://www.suva.ch/waswo)  
 Fax 041 419 59 17  
 Tel. 041 419 58 51

	<b>Isolation devices</b>
	Isolation device (breathing apparatus) for remaining in dangerous atmospheres and for rescue operations.
	<b>Isolation devices</b>
	Isolation devices for self-rescue (self-contained open-circuit compressed air breathing apparatus and regenerative devices) for remaining in channels and for first supply of persons injured
	<b>Rescue harness</b>
	Rescue harness or safety clothing with sewn-in neck eyelet. During the rescue operation, the rescue rope is attached to the neck eyelet. Lifting the injured person is carried out, e.g. By means of a rescue lifting device with automatic load backstop.
	<b>Suitable work clothing</b>
	Closed work clothing protects against contamination of skin and possible infections. Visually noticeable work clothing should make the employees more visible for road users.
	<b>Suitable shoes</b>
	The safety shoes should, in particular, offer good support as well as be anti-slip and leak proof (e.g. Rubber boots).

**Gloves**

Suitable gloves protect against hand injuries and contact against substances hazardous to health and contaminated water.

**Hard hat**

The hat protects the persons head against falling objects as well as against knocking against fixed components and objects.

**Ear protection**

For noise which can damage hearing, e.g. ear protector capsules with integrated headset can be worn.

**Eye protection**

If there is a danger from splitters, splashing of hazardous substances, etc. eyes must be protected.

**Network-independent lighting**

For example, a splash-proof torch or a lamp fixed to a hard hat must be carried.

## 1.9 ⚠️ General safety instructions

### Danger! | High-pressure water jets



Defective or incorrect operation of the product may generate dangers from splash water under pressure. Before operation, ensure the trouble-free state of the product. Powerful water jets may cause severe injuries or even sever limbs. Non-observance of the safety instructions may result in **death** or very serious injuries!

### Danger! | Poisonous vapours



Channels may contain poisonous vapours. Wear the prescribed protective equipment such as gas masks, gas alarms and rescue harnesses. Inhaling poisonous vapours or air contaminated with particles may result in **death** or very serious injuries from the particles penetrating into the lungs!

### Warning! | Parts falling down



In the area of open shafts, objects may fall into the shaft on top of persons working there. When inserting the product, never remain directly under the shaft opening. Secure the shaft access against parts that may fall down. Do not throw any tools or objects into the shaft. Never access shafts that are in danger of collapsing. Persons could be buried. Non-observance of safety instructions may result in **death** or very serious injuries!

### Warning! | Chemical burns



Channels may contain unknown, corrosive or other harmful substances. Wear the respective protective clothing. Use the prescribed protective equipment. Chemical burns to skin and eyes as well as infections with pathogens may be the consequence.

### Warning! | Risk of falling



In the area where work is carried out using the product, open shafts are to be expected. Open shafts must be indicated. Take care where you step. Persons falling may result in **death** or very serious injuries!

**Warning! | Hand injuries**

With a modification of the product, there is a risk of hand injuries from entrapment or abrasion. Wear gloves when working. Observe where you hold the product. Carry heavy devices with the assistance of a second person. This may result in crushing, abrasion up to the severing of limbs.

**Caution! | Tipped objects**

With a modification of the product, there is a risk of hand injuries from sharp edges. Wear gloves when working. Observe where you hold the product. This may result in cut injuries to hands and other body parts.

**Caution! | Risk of falling**

In the area where work is carried out with the product, lines and objects are to be expected on the ground. Take care where you step. Keep the operating area clean and tidy. Falling caused by tripping may result in injury.

## 2 Rights

### 2.1 Copyright

This manual may not be partially or completely copied, photocopied, reproduced, translated or converted in an electronically of machine-readable form without the prior written consent of **enz® technik ag**.

©2024 enz® technik ag, CH-6074 Giswil.

All rights reserved.

### 2.2 Disclaimer

The manufacturer is not liable for damage that:

- has resulted in conjunction with modifications to the product carried out at your own authority.
- have resulted from disregarding the safety instructions.

### 2.3 Guarantee conditions

In line with our terms of sales and delivery, we issue a guarantee. However, the guarantee is omitted:

- When used under conditions stipulated otherwise by us.
- When using replacement or accessory parts that are not original from **enz® technik ag**.
- In event of damage caused by:
  - Incorrect handling
  - Non-observance of the operating instructions
  - Unsuitable operating material
  - Routing of the hose or pipelines incorrectly or inappropriately
  - Changes, modifications or conversions to the product at your own authority.

## 3 Environment

### 3.1 Disposal

Old devices have valuable recyclable materials that should be recycled. Thus, please dispose of the old device via appropriate collecting points.

### 3.2 Environmental protection

Please observe that surfaces can only be cleaned where the composition is known. Chemicals or other poisonous substances must never be released to the environment. Take care to avoid excessive use of water. In this way, you help to protect natural resources.

## 4 Technical data

### 4.1 Introduction

The enz<sup>®</sup> Recycling impact milling cutters have been designed for the milling of extremely hard deposits in pipes. Due to the turbine drive, the recycling impact milling cutters are suitable for operation with recycled and fresh water. The recycling impact milling cutter has a impact of 600– 3,000 impacts per minute and that being with an impact force of up to 12 tons. Depending on the hardness of the deposits, carbide or diamond teeth are used.

The recycling impact milling cutters have a modular design. In the application area of  $\varnothing 200 - 250$  mm and  $\varnothing 300 - 350$  mm, the respective head can be mounted to the hub. The skids are set to the respective diameter on the same body.

### 4.2 Area of application

- Calcareous layers
- Concrete
- Injection cement
- Etc.

### 4.3 Designation of the parts

#### 4.3.1 14.2xxR

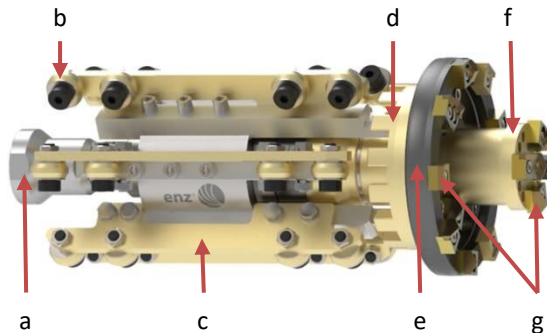


Figure 1: Designation of the parts 14.250R

#### 4.3.2 Legend 14.2xxR

- |                               |                |                  |
|-------------------------------|----------------|------------------|
| a: Swivel joint               | d: Hub         | g: Cutting teeth |
| b: Runner $\varnothing 40$ mm | e: Cutter head |                  |
| c: Skid                       | f: Centre cap  |                  |

Table 1: Legend 14.250R

4.3.3 14.3xxR & 14.4xxR

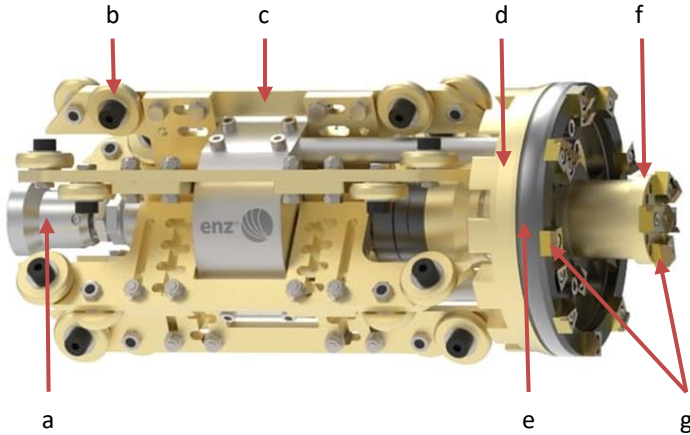


Figure 2: Designation of the parts 14.300R & 14.4xxR

4.3.4 Legend 14.3xxR & 14.4xxR

- a: Swivel joint
- b: Roller Ø 60 mm
- c: Skid
- d: Hub
- e: Cutter head
- f: Centre cap
- g: Cutting teeth

Table 2: Legend 14.300R & 14.4xxR

4.4 Legend for technical data

	Connecting thread [“]		Rotating nozzles / bore
	Weight [kg]		Thrust jet
	Mass		Area of application
	Maximum operating pressure		min. flow rate at 100 bar

Table 3: Legend for technical data



4.5 14.2xxR



Order no.							$\varnothing \times L$					
					mm	inch	mm	inch	l/min	US gpm	bar	psi
14.200R	BSPP 1" BSPP 1 1/4"	3xM10	3xM10	43.4	200	7.9	176x587	6.9x23.1	200	53	150	2,200
14.225R	BSPP 1" BSPP 1 1/4"	3xM10	3xM10	46.0	225	8.9	205x587	8.1x23.1	200	53	150	2,200
14.250R	BSPP 1" BSPP 1 1/4"	3xM10	3xM10	52.3	250	9.8	225x587	8.9x23.1	200	53	150	2,200

Table 4: Technical data 14.2xxR

4.6 14.3xxR

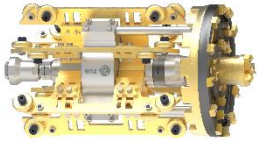


Order no.							$\varnothing \times L$					
					mm	inch	mm	inch	l/min	US gpm	bar	psi

14.300R	BSPP 1" BSPP 1 1/4"	3xM10	3xM10	96.1	300	11.8	288x712	11.3x28.0	260	69	150	2,200
14.350R	BSPP 1" BSPP 1 1/4"	3xM10	3xM10	98.6	350	13.8	338x712	13.3x28.0	260	69	150	2,200

Table 5: Technical data 14.3xxR

4.7 14.4xxR



Bestell-Nr.							$\varnothing \times L$					
					mm	inch	mm	inch	l/min	US gpm	bar	psi
14.400R	BSPP 1" BSPP 1 1/4"	3xM10	3xM10	115.5	400	15.7	388x712	15.3x28.0	350	92.5	150	2'200
14.450R	BSPP 1" BSPP 1 1/4"	3xM10	3xM10	119	450	17.7	439x712	17.3x28.0	350	92.5	150	2'200

Table 6: Technical data 14.4xxR

## 4.8 Tightening torques of the screws

### 4.8.1 14.2xxR

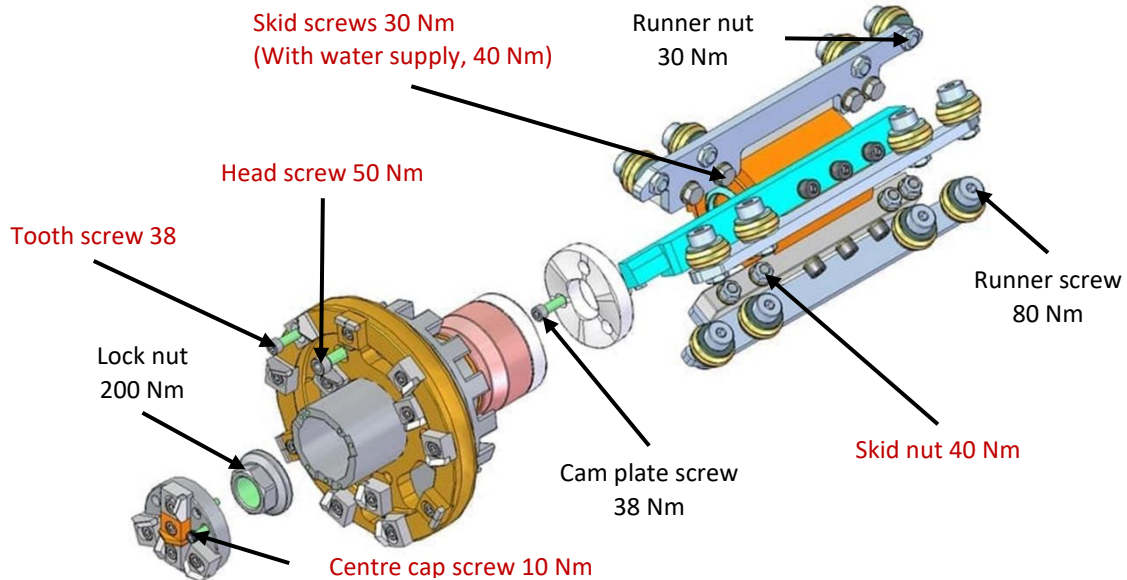


Figure 3: Tightening torques 14.2xxR



### CAUTION!

At the beginning, all tightening torques written in **red** must be checked with a torque wrench after two minutes, and then every hour. This may result in damage to the milling cutter or to parts flying around.

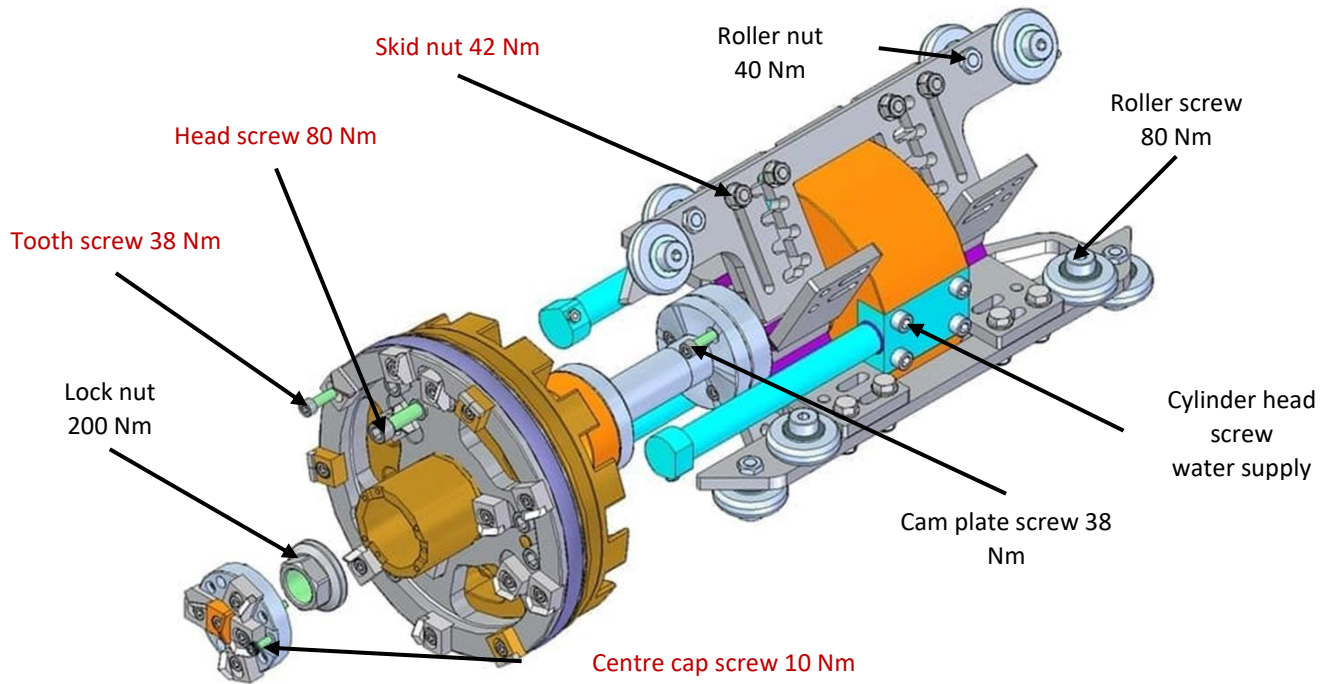


Figure 4: Tightening torques 14.3xxR



**CAUTION!**

At the beginning, all tightening torques written in **red** must be checked with a torque wrench after two minutes, and then every hour. This may result in damage to the milling cutter or to parts flying around.

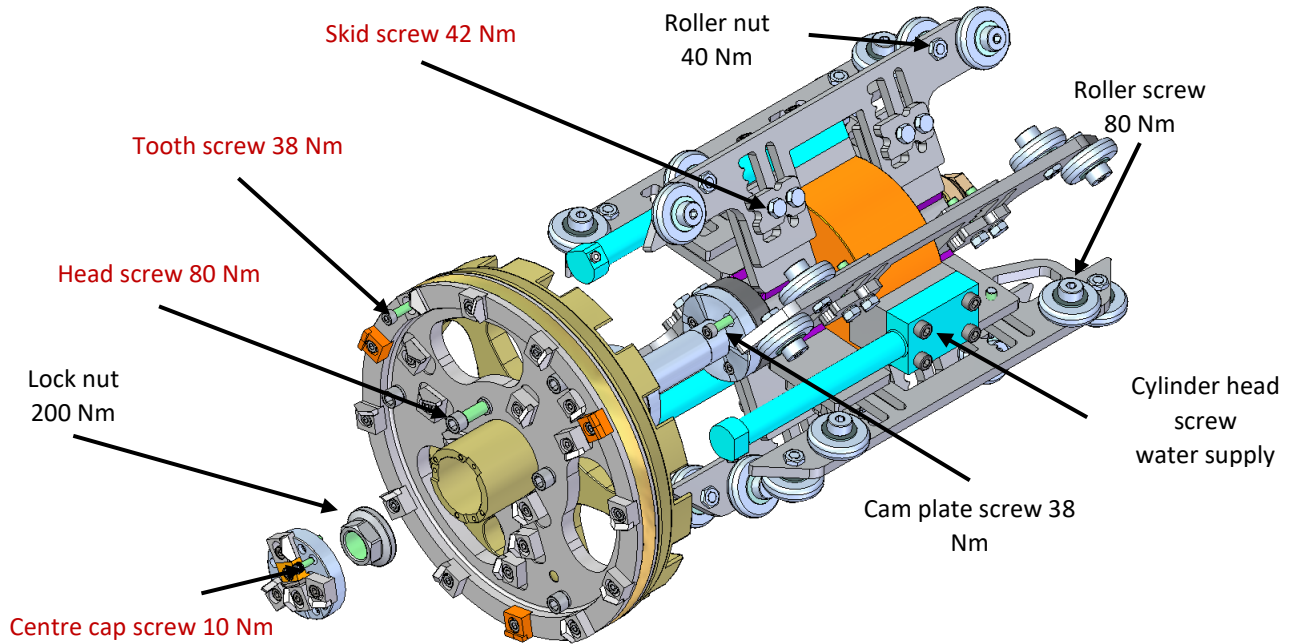


Figure 5 Tightening torques 14.4xxR

**CAUTION!**

At the beginning, all tightening torques written in **red** must be checked with a torque wrench after two minutes, and then every hour. This may result in damage to the milling cutter or to parts flying around.



## 5 Cutting teeth

### 5.1 Overview of cutting teeth

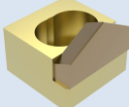
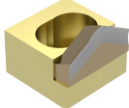
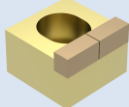
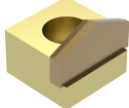

Figure	Article number	Area of application
	15.ZU	Calcareous layers
	15.ZU-GSL	Plastic
	15.ZHU	Calcareous layers
	15.Z1	Calcareous layers Concrete
	15.ZD	Concrete

Table 7: Overview of cutting teeth

## 5.2 Cutting teeth on the centre cap

With the centre cap, take care that the outer carbide tooth 15.ZU are always offset to the outside and the inner carbide tooth 15.ZU is always mounted in the neutral position. The centre tooth 15.Z1 must be mounted precisely in the middle.

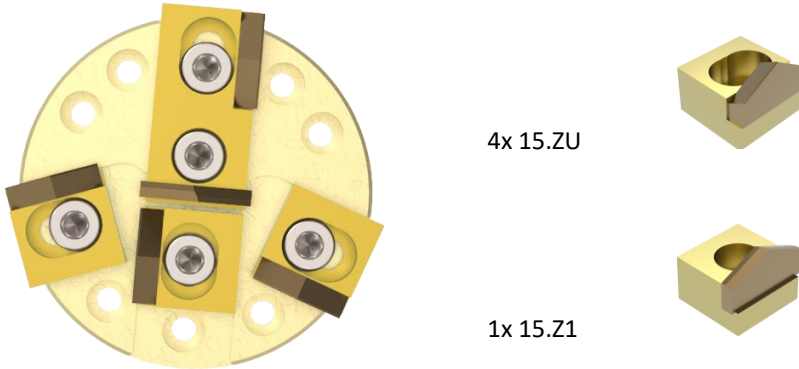


Figure 6: Cutting teeth on the centre cap

## 5.3 Cutting teeth on the inner ring

All cutting teeth on the inner ring of the cutter head are always mounted in the neutral position. The universal tooth made of carbide 15.ZU is mounted as standard.

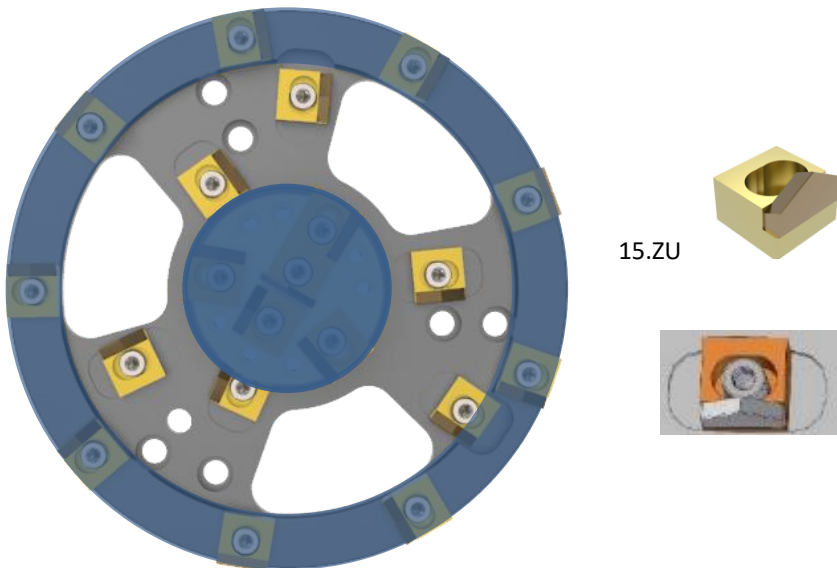


Figure 7: Cutting teeth on the inner ring



### 5.4 Cutting teeth on the outer ring

As standard, three carbide impact cutters 15.ZHU are always mounted on the outer ring which protect the remaining universal cutting teeth 15.ZU against excessive wear. As standard, the universal cutting teeth 15.ZU on the outer ring are mounted in the neutral position. For cutting in plastic pipes, the cutting teeth must be offset inwards. With increasing deposits, the universal cutting teeth 15.ZU can be moved to the “outside” in order to cut the deposits.

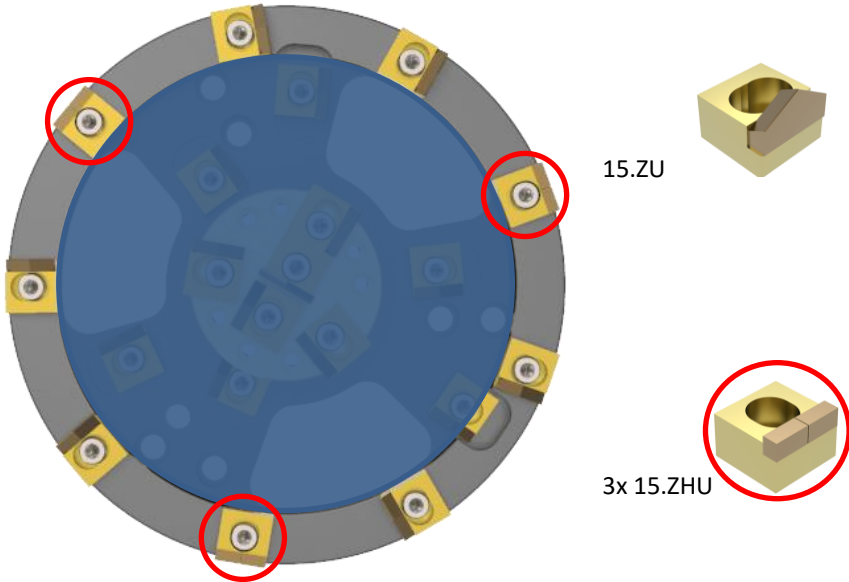





Figure 8: Cutting teeth on the outer ring

## 5.4.1 Tooth position on the outer ring

	<b>As standard, the universal cutting teeth 15.ZU are mounted in the neutral position for calcareous deposits in concrete or steel pipes.</b>
	In cast, steel and concrete pipes, the universal cutting teeth can be mounted offset to the “outside”.
	In plastic pipes, the universal cutting teeth 15.ZU are offset to the “inside” in order not to damage the wall of the pipe.

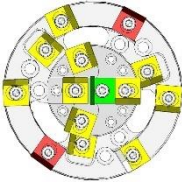
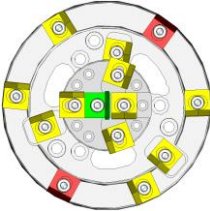
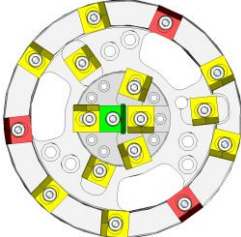
*Table 8: Tooth position on the outer ring*



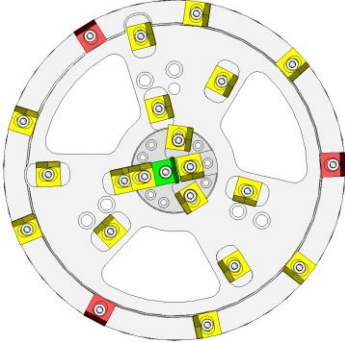


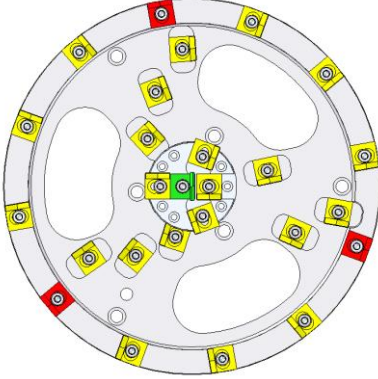
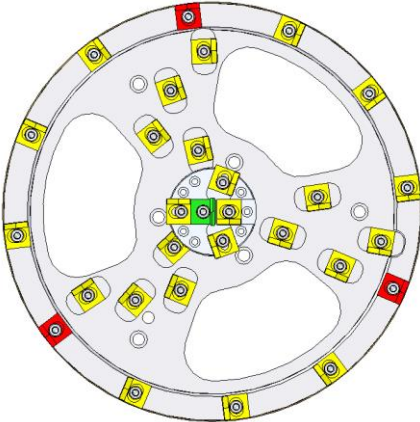
The ground teeth 15.ZU-GSL for plastic or wooden deposits are always mounted in the neutral position.

### 5.5 Equipping for calcareous deposits

To cut calcareous deposits, the normal centre cap must be used. The cutter head is equipped with universal cutting teeth 15.ZU in the neutral position and two or three peripheral cutting teeth 15.ZHU on the outer ring.

Figure	15.ZU	15.ZHU	15.Z1
<p><b>14.200R</b></p> 	11	2	1
<p><b>14.225R</b></p> 	11	2	1
<p><b>14.250R</b></p> 	13	3	1

<p><b>14.300R</b></p> 	<p>16</p>	<p>3</p>	<p>1</p>
<p><b>14.350R</b></p> 	<p>17</p>	<p>3</p>	<p>1</p>
<p><b>14.375R</b></p> 	<p>18</p>	<p>3</p>	<p>1</p>

<p><b>14.400R</b></p> 	<p>22</p>	<p>3</p>	<p>1</p>
<p><b>14.450R</b></p> 	<p>25</p>	<p>3</p>	<p>1</p>

*Table 9: Equipping 14.xxxR for calcareous deposits*

**5.5.1 Calcareous deposits in plastic pipes**

The normal centre cap is used to cut calcareous deposits in plastic pipes. The universal cutting teeth 15.ZU on the outer ring are mounted offset to the “inside” and the peripheral cutting teeth 15.ZHU are replaced by 15.ZU.

### 5.6 Wood and plastic deposits

Specially ground teeth 15.ZU-GSL are used to cut wood and plastic deposits in pipes. These teeth are mounted on the outer and inner ring in a neutral position. The peripheral cutting teeth 15.ZHU are also replaced by 15.ZU-GSL. The normal centre cap is used for the milling work.

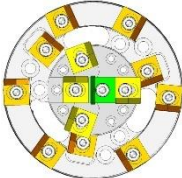
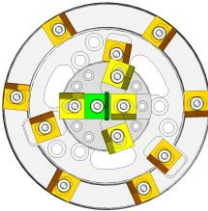
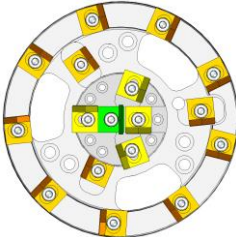
Figure	15.ZU	15.ZU-GSL	15.Z1
<p><b>14.200R</b></p> 	4	9	1
<p><b>14.225R</b></p> 	4	9	1
<p><b>14.250R</b></p> 	4	12	1

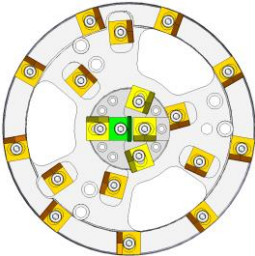


Figure	15.ZU	15.ZU-GSL	15.Z1
<p><b>14.300R</b></p> 	4	15	1
<p><b>14.350R</b></p> 	4	16	1
<p><b>14.375R</b></p> 	4	17	1

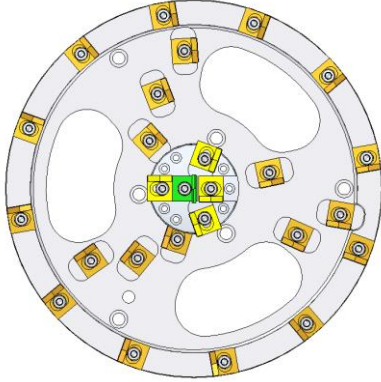
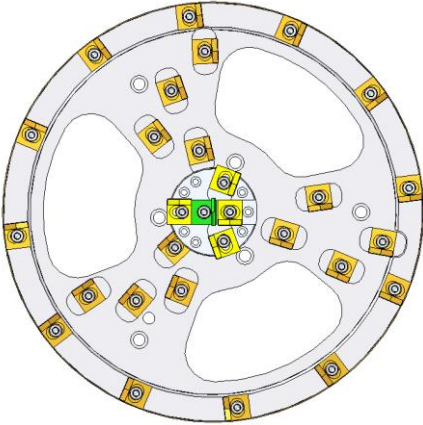
Figure	15.ZU	15.ZU-GSL	15.Z1
<p><b>14.400R</b></p> 	4	21	1
<p><b>14.450R</b></p> 	4	24	1

Table 10: Equipping 14.xxxR for wood and plastic deposits



If the pipe is filled half full with plastic deposits, the ground teeth 15.ZU-GSL can also be mounted on the centre cap.



### 5.7 Equipping for concrete deposits

For extremely hard deposits, such as concrete where the impact milling cutter with the universal cutting teeth no longer provides the necessary performance, diamond teeth should be mounted. The diamond teeth are mounted on the complete outer ring.

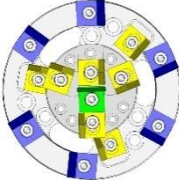
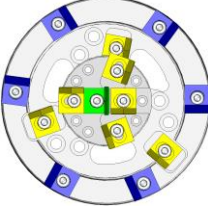
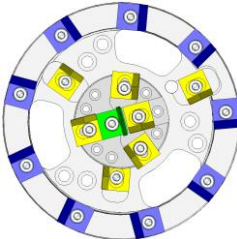
Figure	15.ZU	15.ZD	15.Z1
<p><b>14.200R</b></p> 	7	6	1
<p><b>14.225R</b></p> 	7	6	1
<p><b>14.250R</b></p> 	7	9	1

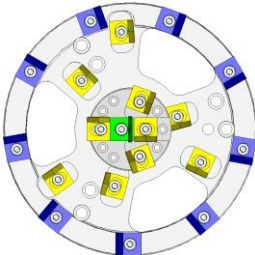
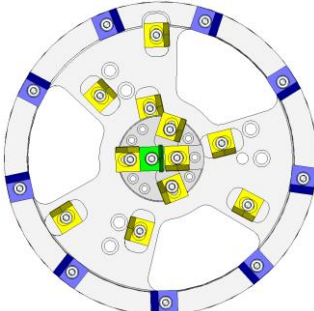
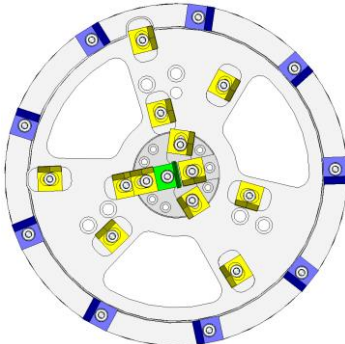
Figure	15.ZU	15.ZD	15.Z1
<p><b>14.300R</b></p> 	10	9	1
<p><b>14.350R</b></p> 	11	9	1
<p><b>14.375R</b></p> 	12	9	1

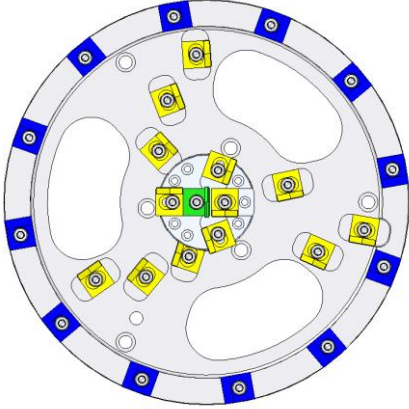
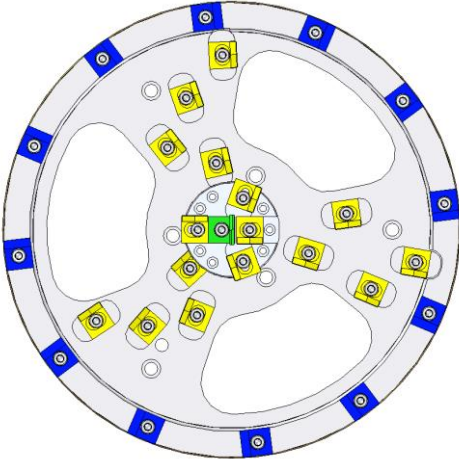
Figure	15.ZU	15.ZD	15.Z1
<p><b>14.400R</b></p> 	13	12	1
<p><b>14.450R</b></p> 	16	12	1

Table 11: Equipping 14.xxxR for concrete deposits

## 5.8 Teeth position overview

Pipe material	Deposit			Tooth position
	Lime	Concrete	Plastic	
Concrete- and Cast-Iron pipe	With	With	Without	Neutral
				Inside
Plastic pipe				Neutral
	Without	Without	Without	Inside
15 ZU			Percussion:	With
15 ZU-GSL				Without
15 ZD				

## 6 Installation

### 6.1 Equipping

To match the recycling impact milling cutters optimally to the flushing vehicle, enz® technik ag needs the following parameters for each order:

- |                    |                   |          |
|--------------------|-------------------|----------|
| • Pumping capacity | [l/min]           | [US gpm] |
| • Pump pressure    | [bar]             | [psi]    |
| • Hose diameter    | [mm]              | [inch]   |
| • Hose length      | [m]               | [feet]   |
| • Hose material    | Plastic or rubber |          |
- 



If changes are made to the parameters, you should check the coordination of the recycling impact milling cutter.

---

### 6.2 Assembly of the tools

The tools are supplied ready for use and are set to «Milling with impact» ex-factory. After unpacking, check, that the delivery is complete. Then the recycling impact milling cutter is screwed onto the pressure hose. The recycling impact milling cutters have different thread dimensions which are apparent in the chapter “Technical data” from page [15](#).

As standard, the recycling impact milling cutters rotate counter-clockwise.

---



When screwing on the pressure hose, make sure that no contamination can enter in the tool. Particles may clog the inserts.

---

### 6.3 Preparation work

The following points must be clarified with the customer:

- Organise plans where the pipeline route is apparent
- Photographic and video material of the pipe condition and deposits
- Clarify the pipe material, pipe condition and pipe route (only straight)
- Precise internal diameter and pipe length
- Material type of the deposits in the pipe and content in % against the diameter
- Length of the deposits in the pipe
- Direction of flow of the water
- Inclination in percent or degrees
- Access to the pipe (2/3 of a tool length must be free)
- Have the exclusion of liability signed by the customer

## 6.4 Setting up the workplace

Before starting work, the following measures must be taken:

- ⚠ Install any barriers and protective equipment (Triopan warning sign, fencing ropes, etc.).
- ⚠ The working area must be cordoned off such that there is no danger for other persons.
- ⚠ Obtain the necessary information about the waste water introduced to the pipe (chemical substances, gases, vapours, etc.).
- ⚠ The necessary measuring devices such as explosimeter, oxygen meter, gas alarm, etc. must be ready for use.
- ⚠ Make sure that the suitable nozzles are present for the pipe cleaning. The area of application of each nozzle is apparent in chapter "Technical data", from page **15**.
- ⚠ The pipe run (plans) must be known before starting work in order to prevent the nozzle from exiting at the end of the line. Possible exit location must be monitored by support staff.
- ⚠ The surface of the workplace must be clean and have sufficient grip, loose obstructions at the workplace must be removed.
- ⚠ Ensure that the workplace is sufficiently illuminated.
- ⚠ The workplace must be dimensioned such that the operator has sufficient freedom of movement and can assume a stable working posture.
- ⚠ The workplace must ensure that water can drain or run away.
- ⚠ Scaffolding must be fixed, stable and secured against tipping, moving and falling over.
- ⚠ Work platforms must be set up in a stable manner and must not be moved by the cleaning work.
- ⚠ Scaffolding and work platforms must comply with the standards on occupational protection and may only be installed by trained specialist personnel.
- ⚠ Loose parts to be cleaned must be secured before commencing work.



If you cut in the direction of flow or against the direction of flow, or in pipes with slopes or inclines, the thrust nozzles must be adapted.

---

## 6.5 Concluding work

After finishing your work, check the cleaned pipes using a channel inspection camera. Observe in particular if there is any damage as well as if fluids are leaking into the environment. After you have finished cleaning the channels, close all shafts again.

## 7 Operation

### 7.1 Operating principle

The recycling impact milling cutter is guided in the pipe with the runners on the skirts (1). The thrust nozzles (2) generate the thrust force and pushes the recycling Impact milling cutter forwards in the pipe. The swivel joint (3) between the recycling impact milling cutter and hose prevents the hose from twisting. The cutter head (4) is sped up to 5,000 - 6,000 rpm at idle by the turbine (5) and drive nozzles (6). During use, it rotates at 200 - 1,000 rpm. In doing so, the carbide teeth (7) cut the deposits away with a cadence of 600 - 3,000 impacts per minute and up to 12 tons of impact force.

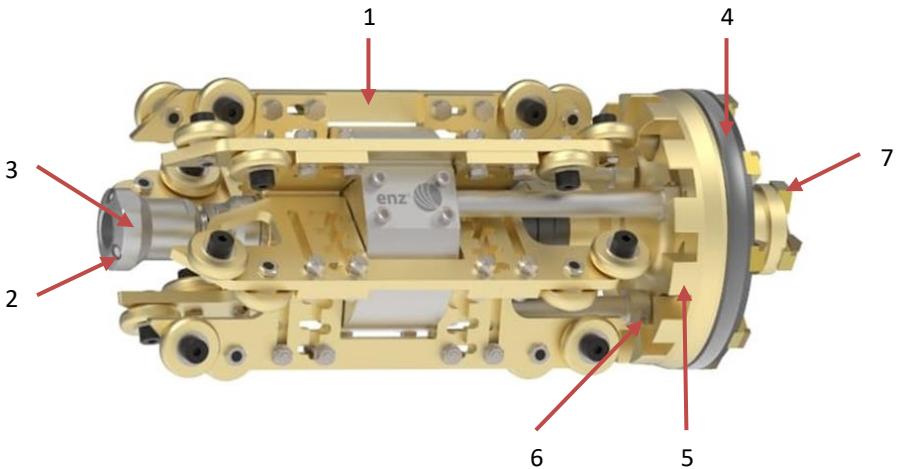


Figure 9: Operating principle

### 7.2 Nozzle inserts

The three thrust nozzles (2) which are mounted on the swivel joint (3) can be exchanged for the respective work deployment at any time. This controls the contact pressure and the forwards sliding of the tool. For the milling project, organise different nozzle inserts for the thrust in advance. Changing the nozzle inserts is described in chapter "Changing the nozzle inserts" on page [53](#).

When equipped correctly, the impact milling cutter works quicker and more efficient.



Please observe that in most cases, the thrust nozzles have to be adapted.

### 7.3 Operating the tool against the direction of flow

1. Before cutting completely rinse the loose stones out of the pipe with a standard nozzle. Loose stones may impair work and damage the teeth of the recycling impact milling cutter.
  2. Check the condition of the pipe using a camera and prepare an as-is survey.
  3. Check the screws with the torque wrench according to page **20** and then guide the recycling impact milling cutter into the pipe.
  4. Push the recycling impact milling cutter into the pipe to be cleaned by at least half of its length.
  5. Allow the recycling impact milling cutter to start-up with approx. 80 bar and guide it up to the deposits.
  6. Slowly increase the pressure on the recycling impact milling cutter to 100 bar. In normal cases, the pipe can be efficiently cleaned with this pressure.
  7. Perform work with the high-pressure hose in your hand and feel the vibrations from the impact. As soon as you can no longer feel any vibrations, pull the recycling impact milling cutter back a little and then slowly guide it back to the deposits.
  8. Stop work after 2 minutes, take out the recycling impact milling cutter and check the teeth again using a torque wrench according to page **20**.
  9. Check the condition of the pipe with a camera now, and inspect the pipe for any pipe damage.
  10. Now insert the recycling impact milling cutter back into the pipe and continue with the cutting work.
  11. Grease the hub via the grease nipple every two hours with Germes 101 (14.99008).
  12. Then check the teeth of the recycling impact milling cutter for damage and wear every hour. Also check the screws of the teeth and head screws for their tight fit using a torque wrench according to **20**. Repeat this step every hour.
  13. Check the screws on the cage at least once a day with a torque wrench according to page **20** for tightness
  14. Monitor work regularly using a camera.
  15. For a good result, after cutting, clean the pipe all around using a rotary nozzle or chain scraper.
  16. After completing work, close all shaft covers.
- 



If possible, always work in the direction of flow in order not to interrupt the flow of water in the channel.

---



### 7.4 Operating the tool in the direction of flow

If water cannot drain to the front in a sloping pipe, first this has to be pumped away to allow the recycling impact milling cutter to work efficiently.

When the water rises, the counter water pressure to the recycling impact milling cutter increases and increasingly reduces the impact force. You can recognise this on the vibration reducing on the hose.

With a strong increase, the vibration on the hose is severely damped that can almost not be noticed. The operator can no longer assess if the recycling impact milling cutter rotates or is stationary. It is a great help if an employee with radio contact to the operator goes to the next shaft to listen if there are any cutting noises and observe if water runs out. Impacting noises confirm the good cutting operation.



In event of insufficient impact force, pump out the pipe in order to then be able to work more efficient again.



If the water can drain but too much water is added during operation, pull the recycling impact milling cutter back by 0.5 metres and interrupt work until the water has drained.



Observe that in most cases, the thrust nozzles have to be adapted when milling in the direction of flow or against the direction of flow, or for greater inclinations.



Protect the hose against wear from coarse surfaces using a flex guide, protective tubing or a deflection roller. This protection increases the service life of the hose significantly.



**CAUTION!**

The recycling impact milling cutter may only be used in pipes installed in a straight line. This may result in significant property damage.



**CAUTION!**

Always use the matching cutter diameter for the respective pipe. Otherwise damage may be caused to the pipe wall and tool.

**CAUTION!**

Never allow the recycling impact milling cutter to jump (pulling the hose back manually and then letting go)! This can result in damage to the pipe and tool.

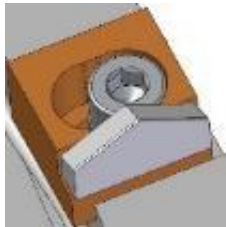
**CAUTION!**

Take care that in event of penetration, do not continue cutting with the recycling impact milling cutter. This may result in damage to the pipe wall and shaft.

## 7.5 Cutting in plastic pipes

### 7.5.1 PE plastic pipes

For plastic pipes, the cutting teeth on the outer ring must be moved to the “inside” to ensure that the pipe is not damaged. Loosen the screws on the outer cutting teeth and take them out. Move the cutting teeth to the inside and then tighten the screws of the teeth to 38 Nm with the torque wrench.



*Figure 10: Tooth position «inside» for plastic pipes*

### 7.5.2 PVC plastic pipes

PVC pipes may only be milled if these are embedded in concrete! Otherwise the same procedure applies as with milling in PE plastic pipes. These means that the cutting teeth on the outer ring must be moved to the “inside” to ensure that the pipe is not damaged.

### 7.6 Milling in a slightly damaged pipe

Slightly damaged pipes generally have cracks in the pipe wall. Please always report such observations to the respective department or authority in writing.

Take great care when working in a slightly damaged pipe. The deployment always takes place at your own responsibility! enz® technik ag accepts no liability whatsoever.



**WARNING!**

By washing out by cracks, pipe fragments may break away and the area around the pipe flushed out. This may result in severe injury and property damage.

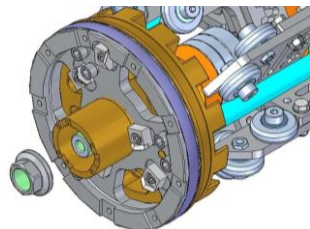
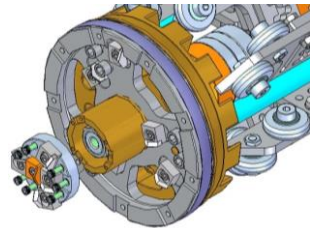
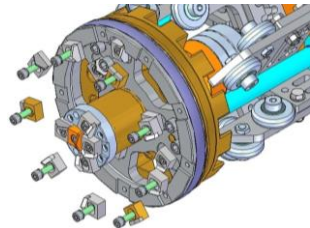


Use a worn pair of cam plates. This provides a softer impact.

### 7.7 Milling with diamond crown

The diamond crown is used to remove shorter elements such as steel reinforcements.

1. Remove all cutting teeth on the “outer ring”.
2. Undo the seven Allen screws and remove the centre cap using a nylon hammer.
  - ! The screws are secured with Tuflok and can be released using an Allen key.
3. Undo the lock nut.



4. Remove the aluminium-bronze washer on the shaft.
5. Remove the hub from the shaft and place the spacer (14.D80) on the shaft. Grease the shaft with Germes 101 (14.99008) and then place the hub back onto the shaft.
6. Grease the aluminium-bronze washer with Germes 101 (14.99008) and then place the aluminium-bronze washer back onto the shaft.
7. Grease the lock nut with Germes 101 (14.99008) and tighten this to 180 Nm with a torque wrench.
8. Place a diamond crown on the cutter head. Coat the three screws with Germes 101 (14.99008), place the Nord-Lock washers on the screws and tighten them to a tightening torque of 38 Nm.
9. From here, follow the steps according to sub-chapter **7.10 Mount the centre cap.**

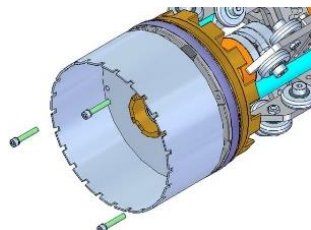
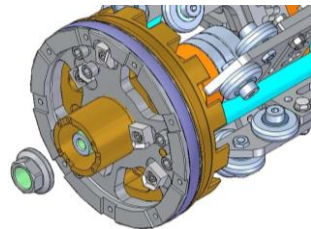
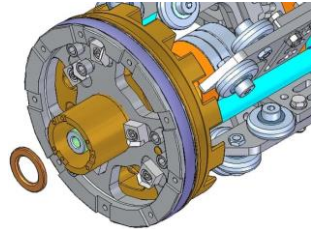
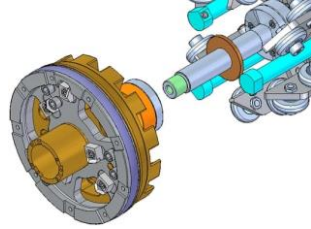
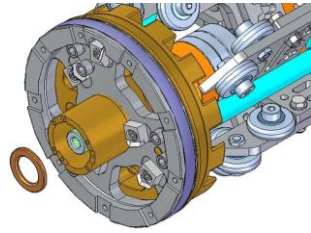


Figure 11: Mounting the diamond crown

## 7.8 After use

There are several points that have to be observed after using the recycling impact milling cutter:

- Flush the recycling impact milling cutter with fresh water.
- Spray the entire recycling impact milling cutter with Oil Spray Bio (C191). Then rotate the cutter head several times by hand.
- Check the carbide teeth for wear and if necessary, replace any defective carbide teeth.
- Tighten all screws on the skids with a tightening torque according to page **20**.
- Grease the grease nipple on the swivel joint after approx. 20 operating hours with a stroke of universal grease from the grease press.

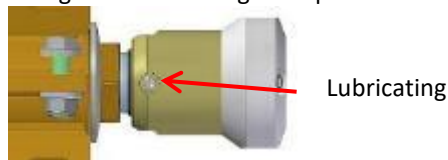


Figure 12: Lubricating nipple

## 7.9 Disassemble the centre cap

1. Undo the seven Allen screws.
  - ❗ The screws are secured with Tuflok and can be released using an Allen key.
2. Remove the centre cap by knocking against the edge of the centre cap equally to the front using a nylon hammer.

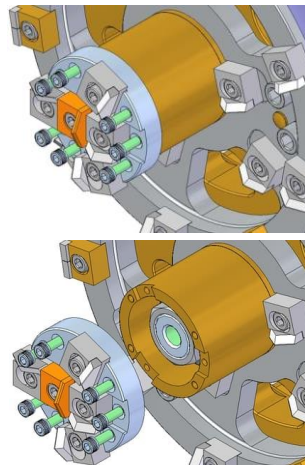
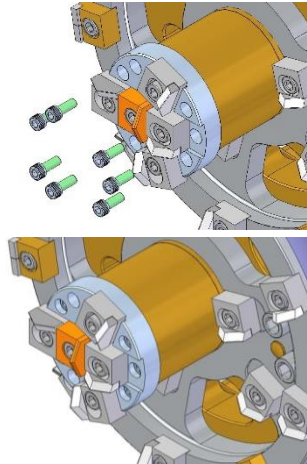


Figure 13: Disassemble the centre cap

## 7.10 Mount the centre cap

1. Clean the support surfaces the internal and external thread of the screws must be free from oil and grease. Place the centre cap onto the hub and apply a coat of Loctite 243 (C192) to the screws.
2. Use a torque wrench to tighten the screws to 10 Nm. Allow the adhesive to dry for at least 24 hours.



*Figure 14: Mount the centre cap*

## 7.11 Mount the pull rod

1. Undo the seven Allen screws.
  - ❗ The screws are secured with Tuflok and can be released using an Allen key.
  
2. Remove the centre cap by knocking against the edge of the centre cap equally to the front using a nylon hammer.
  
3. Replace the centre cap by the centre cap with bored hole (15.ZKB). Apply a coat of Loctite 243 (C192) to the screws and tighten these to 180 Nm with a torque wrench.
  
4. Apply a coat of Loctite 243 (192) to the pull rod and mount this on the shaft with a tightening torque of 180 Nm. Allow the adhesive to dry for at least 24 hours.

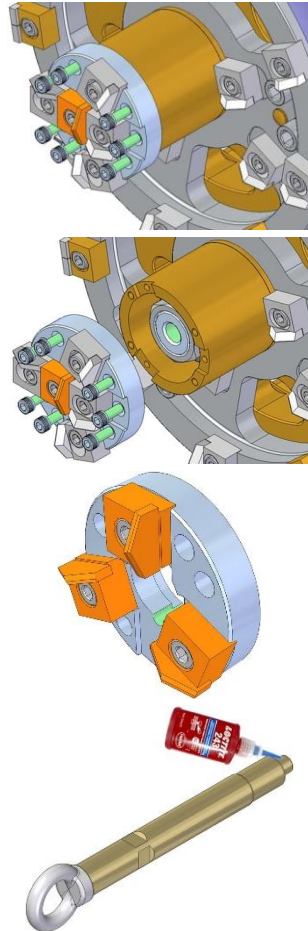
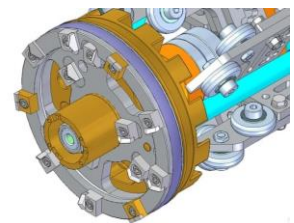
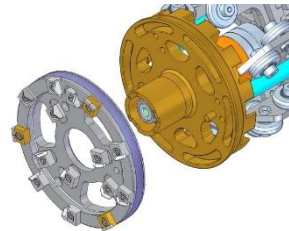
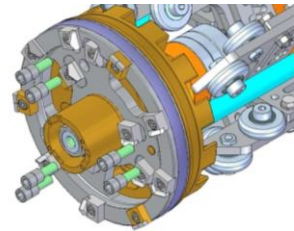
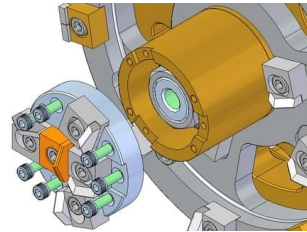
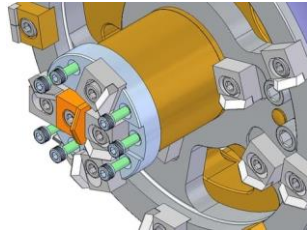


Figure 15: Mount the pull rod

## 7.12 Converting the recycling impact milling cutter (to another diameter)

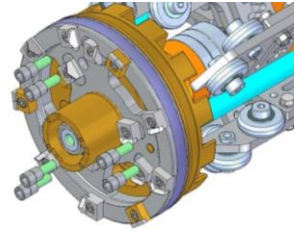
### 7.12.1 Changing the cutter head

1. Undo the seven Allen screws.  
**!** The screws are secured with Tuflok and can be released using an Allen key.
2. Remove the centre cap by knocking against the edge of the centre cap equally to the front using a nylon hammer.
3. Undo the six Allen screws for the cutter head.  
**!** The screws are secured with Loctite, but can still be released using an Allen key.
4. Remove the cutter head from the hub.
5. Clean the support surfaces the internal and external thread of the screws must be free from oil and grease. Then fit a new cutter head, the centre pin specifies the correct position in the process.





- Coat the thread of the six Allen screws with Loctite 243 (C192) and place the bushing on the screw. Then tighten these to a tightening torque of 80 Nm. With the 14.2xxR recycling impact milling cutter, the tightening torque is 50 Nm.

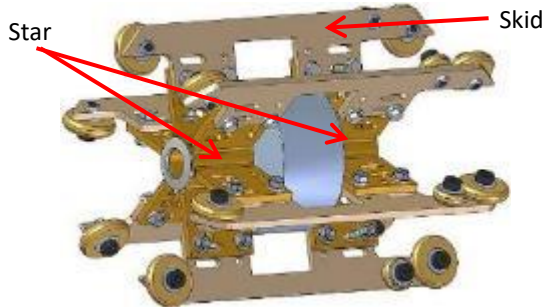


- From here, follow the steps according to sub-chapter **7.10 Mount the centre cap.**

*Figure 16: Changing the cutter head*

### 7.12.2 Set the skids

- Loosen the screws until the screw is loose.
- Offset boreholes or slots are already included in the lugs. These allow you to adjust the skids to the inside or outside.
- Set the desired diameter and tighten the screws to a tightening torque of 42 Nm.



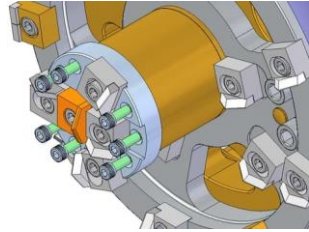
*Figure 17: Set the skids*



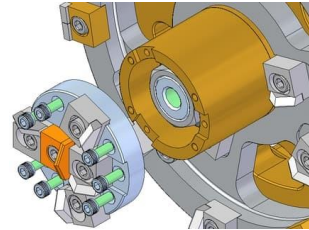
Take care that the skid diameter is approx. 10 mm larger than the cutter head diameter.

## 7.13 Switch the impact off and on

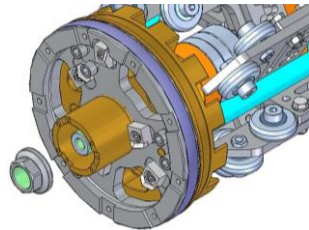
1. Undo the seven Allen screws.  
❗ The screws are secured with Tuflok and can be released using an Allen key.



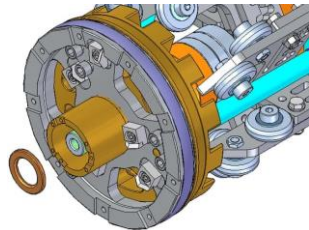
2. Remove the centre cap by knocking against the edge of the centre cap equally to the front using a nylon hammer.



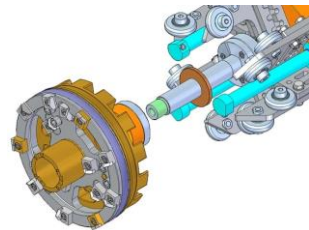
3. Undo the lock nut.



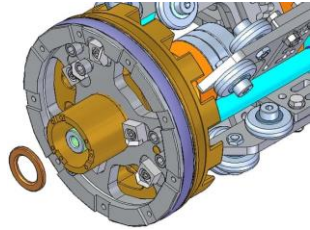
4. Remove the aluminium-bronze washer on the shaft.



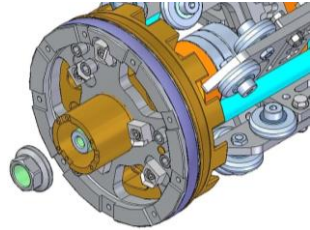
5. Remove the hub from the shaft and place the spacer (14.D80) on the shaft. Grease the shaft with Germes 101 (14.99008) and then place the hub back onto the shaft.



- Grease the aluminium-bronze washer with GERMES 101 (14.99008) and then place the aluminium-bronze washer back onto the shaft.



- Grease the lock nut with GERMES 101 (14.99008) and tighten this to 180 Nm with a torque wrench.



- From here, follow the steps according to sub-chapter **7.10 Mount the centre cap.**

*Figure 18: Switch the impact off and on*



To switch the impact on, follow the work steps 1 – 9, but remove the shock in the process.

## 7.14 Malfunctions

### 7.14.1 The recycling impact milling cutter blocks

1. To start up again, pull the recycling impact milling cutter back a little (approx. 20 – 30 cm).
2. Shake the high-pressure hose such that the impact mechanism is relieved and the milling head can rotate freely again.
3. Move carefully to the deposit and continue working.

### 7.14.2 The recycling impact milling cutter blocks often

Too much thrust → Reduces the thrust nozzles

### 7.14.3 Insufficient impact force

Insufficient impact force can be clearly noticed by a weak vibration of the water hose. Press the milling head on the cam plate and turn it slowly by hand. In doing so, the milling head is guided back and forth by the cam plate. The path of the movement must be at least 2 mm. If the path is smaller, both cam plates are worn and must be replaced (see “Changing the cam plates” on page [56](#)).

### 7.14.4 The recycling impact milling cutter runs upwards

With fewer but harder deposits in the pipe, the tool can slide up on the deposits. Move the carbide teeth on the outer ring to the “outside”. With this measure, you achieve that the tool runs straight and the wall of the pipe is slightly milled. As a result, the pipe becomes a fine smooth surface. After the deposit has been slightly milled, the cutting teeth can be set back to neutral.

## 8 Maintenance

### 8.1 Changing the nozzle inserts

The maintenance and repair activities described in these operating instructions may only be carried out by users who have the necessary knowledge.

### 8.2 Changing the nozzle inserts

After being used each time, the nozzle inserts must be checked visually for damage in order to guarantee an optimum cleaning performance. The wear depends on the degree of contamination of the water used.



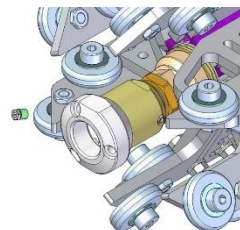
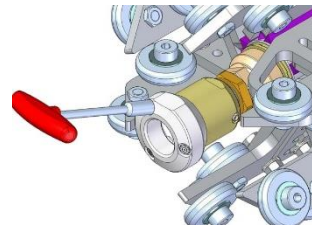
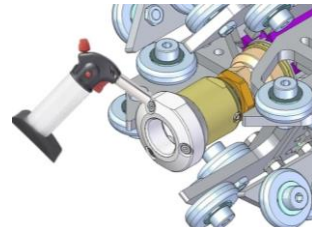
#### CAUTION!

Worn nozzle inserts impair the cleaning performance and there is an increased risk when working with higher pressures. This can result in damage to the tool.

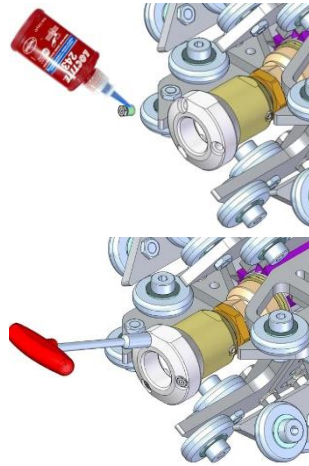
Another reason to change nozzle inserts is a repositioning. In this case, the JetCalc must be used for determination of the nozzle inserts.

Follow the next steps in order to replace the nozzle inserts:

1. Clean the nozzle insert. During the approx. 10 seconds, heat it with the gas torch (C158).
2. Disassemble the nozzle insert using the socket spanner WAF10 (C131).
3. Clean the threaded hole and the new nozzle insert, e.g. with acetone.
  - ❗ The nozzle inserts and the female thread on the tool must be clean, dry and free from oil and grease. Impurities influence the bonding properties.



4. Coat the thread of the nozzle insert with Loctite 243 (C192).
5. Mount the nozzle insert using the socket spanner WAF10 (C131).
6. Leave the adhesive to harden for at least 24 hours at room temperature (approx. 22°C).



*Figure 19: Changing the nozzle insert*



**CAUTION!**

Never use a pipe wrench or pliers with teeth. These may damage the tool or the hose. This may lead to the tool bursting during operation.

### 8.3 Changing the cutting tooth

1. Undo the screws and remove the Nord-Lock washer.
2. Remove the old cutting tooth and clean the support surface.
3. Mount the new cutting tooth in the "Neutral" position (see page [26](#)). Coat the screw with Germes 101 (14.99008) and put on the Nord-Lock washer.
4. Tighten the screw to 38 Nm.

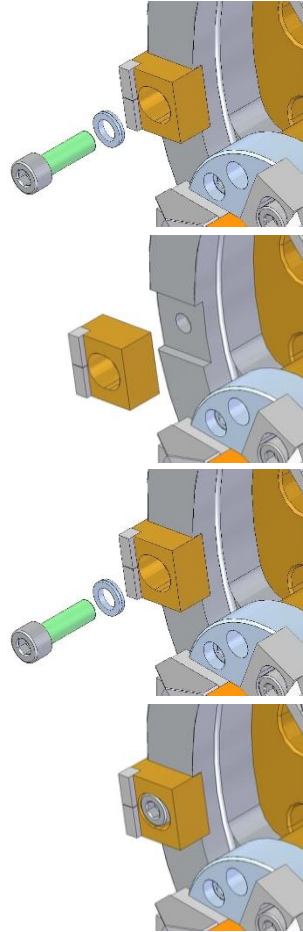

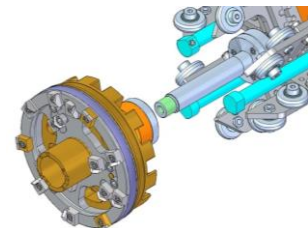
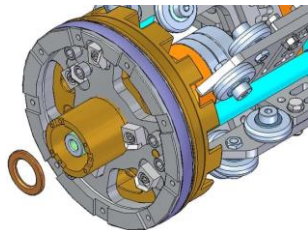
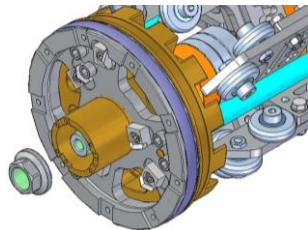
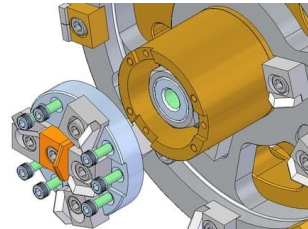
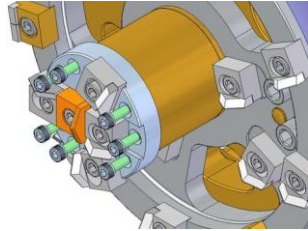


Figure 20: Changing the cutting tooth

## 8.4 Change the cam plates

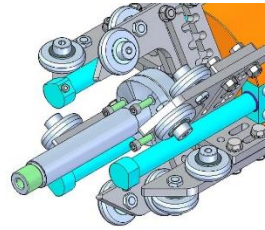
Every now and then, the cam plates art.-no. 14.KR35 must be exchanged (after approx. 50 hours, or when the stroke is less than 2 mm). The wear differs significantly and is orientated on the load of the recycling impact milling cutter.

1. Undo the seven Allen screws.  
 The screws are secured with Tuflok and can be released using an Allen key.
2. Remove the centre cap by knocking against it equally to the front using a nylon hammer.
3. Undo the lock nut.
4. Remove the aluminium-bronze washer on the shaft.
5. Pull the hub off the shaft.

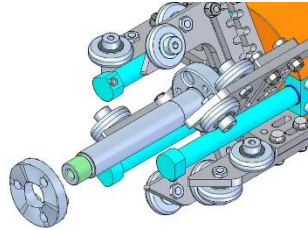




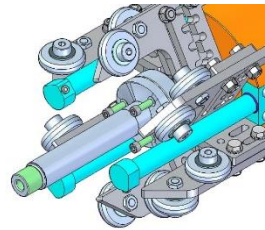
6. Undo the three screws of the cam plate



7. Replace the cam plates with new ones.

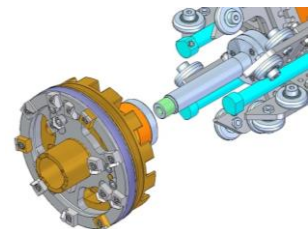


8. Tighten the screws to 38 Nm.

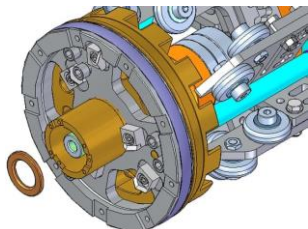


9. Carry out work steps 6 to 8 on the back side of the hub.

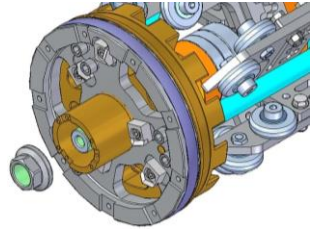
10. Put the hub on the shaft.



11. Grease the aluminium-bronze washer with Germes 101 (14.99008) and then place the aluminium-bronze washer back onto the shaft.



- Grease the lock nut with Germes 101 (14.99008) and tighten this to 180 Nm with a torque wrench.



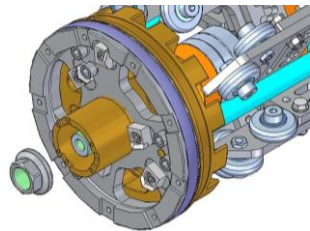
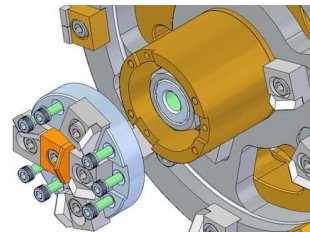
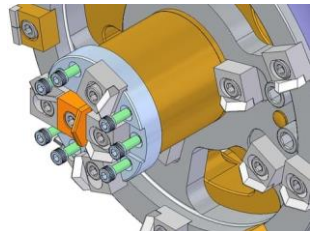
- From here, follow the steps according to sub-chapter **7.10 Mount the centre cap.**

*Figure 21: Change the cam plates*

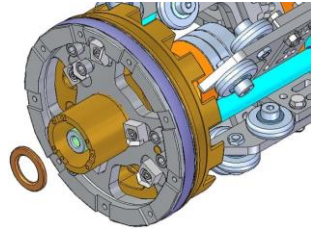
## 8.5 Change the aluminium-bronze washer

The aluminium-bronze washer takes up the torque of the milling head and thus protects the fixed parts. If this is greased insufficiently, wear increases and it has to be changed as soon as it is thinner than 2 mm.

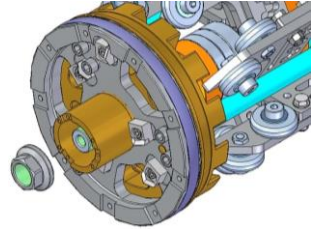
- Undo the seven Allen screws.
  - ⓘ The screws are secured with Tuflok and can be released using an Allen key.
- Remove the centre cap by knocking against it equally to the front using a nylon hammer.
- Undo the lock nut.



4. Replace the aluminium-bronze washer on the shaft with a new one and grease this with Germes 101 (14.99008).



5. Grease the lock nut with Germes 101 (14.99008) and tighten this to 180 Nm with a torque wrench.



8. From here, follow the steps according to sub-chapter **7.10 Mount the centre cap.**

## 8.6 Care

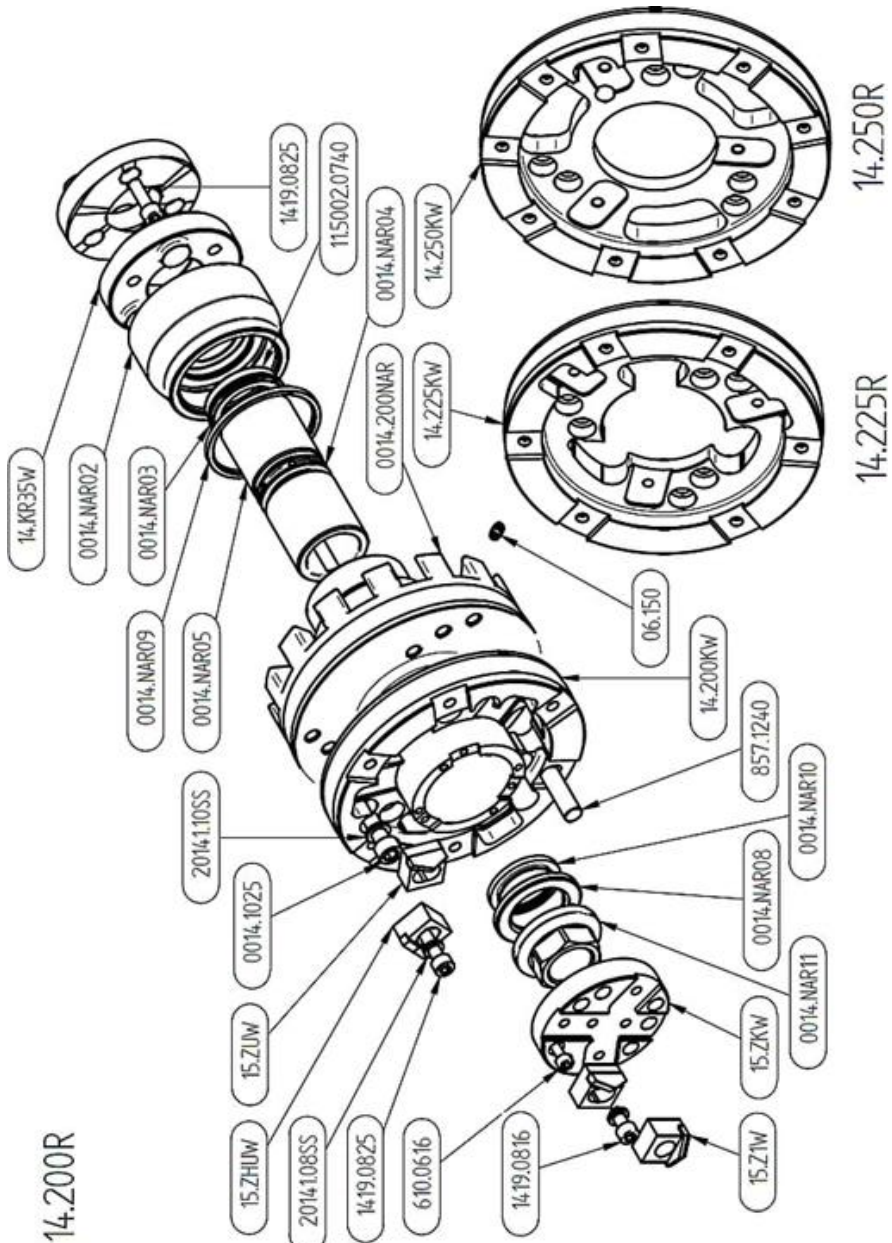
The recycling impact milling cutter must be thoroughly cleaned after being used each time. After cleaning, the recycling impact milling cutter must be sprayed with Motorex Oil Spray Bio (C191) to protect it against corrosion. Lubricate the grease nipple with a stroke of Plantogel grease 4000 (14.99008).

## 8.7 Storage

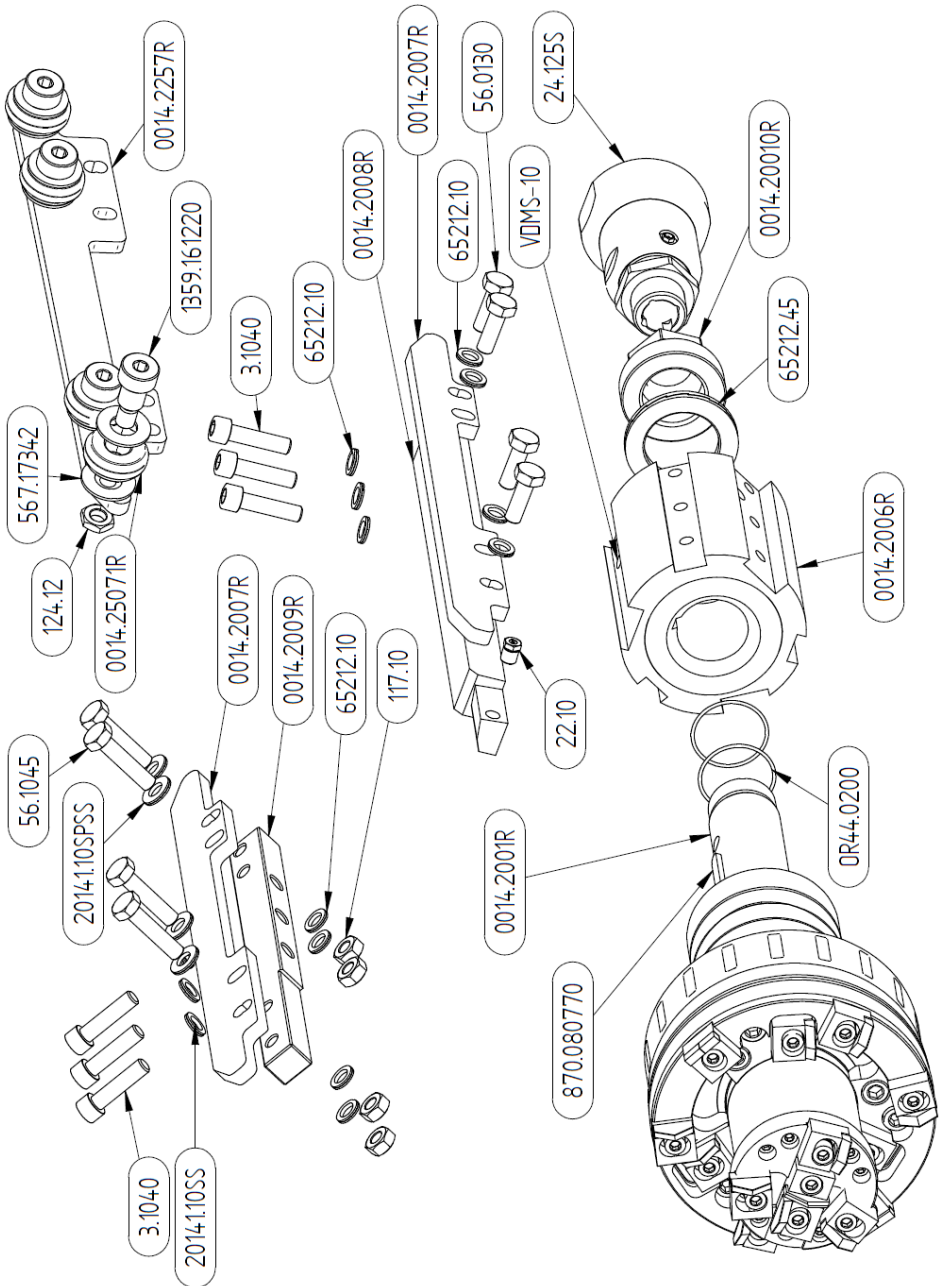
The recycling impact milling cutter must be stored in a dry location.

## 9 Spare parts / Accessories

### 9.1 14.200R-14.250R

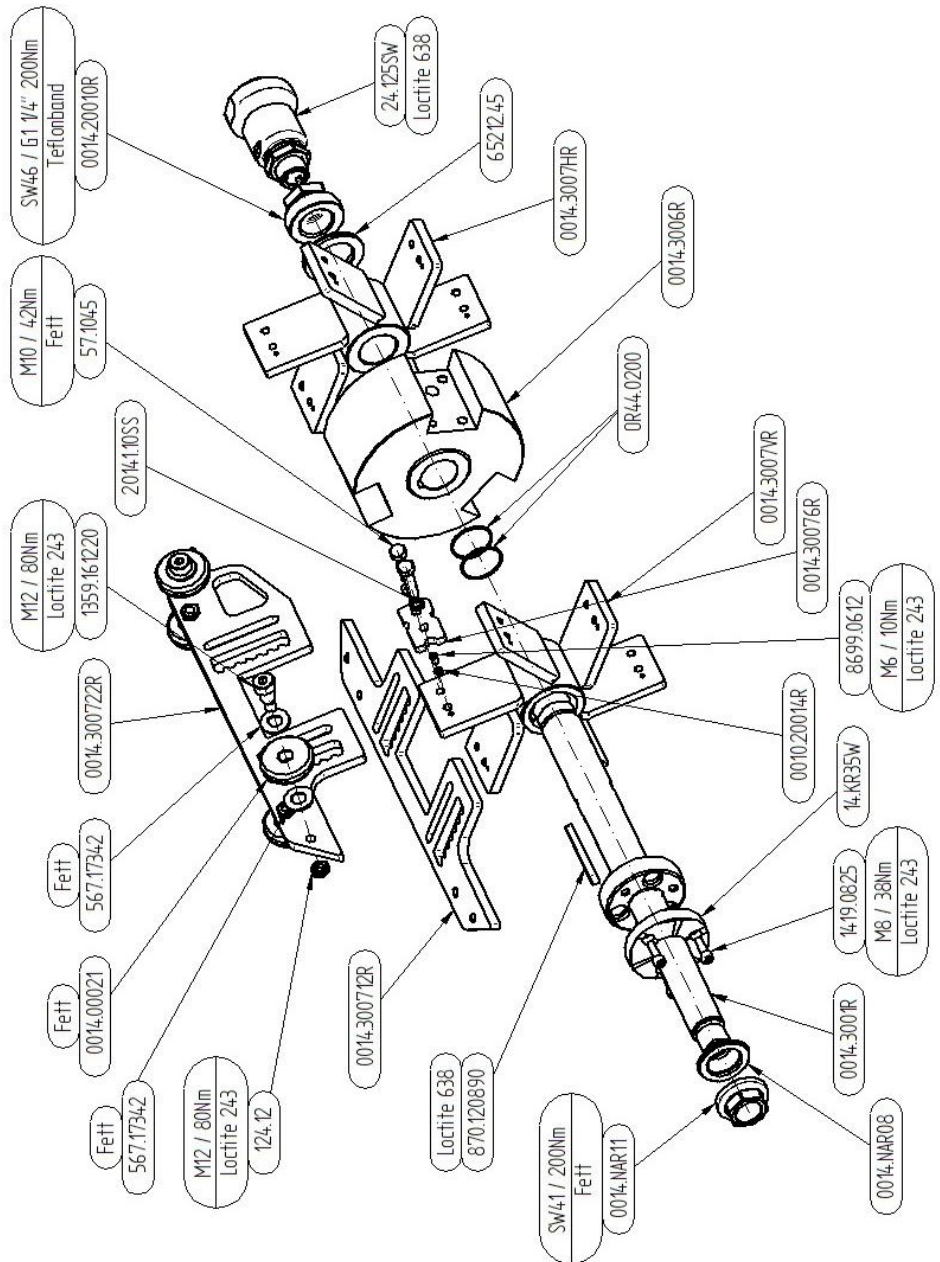


Drawing 1: Explosion 14.2xxR head

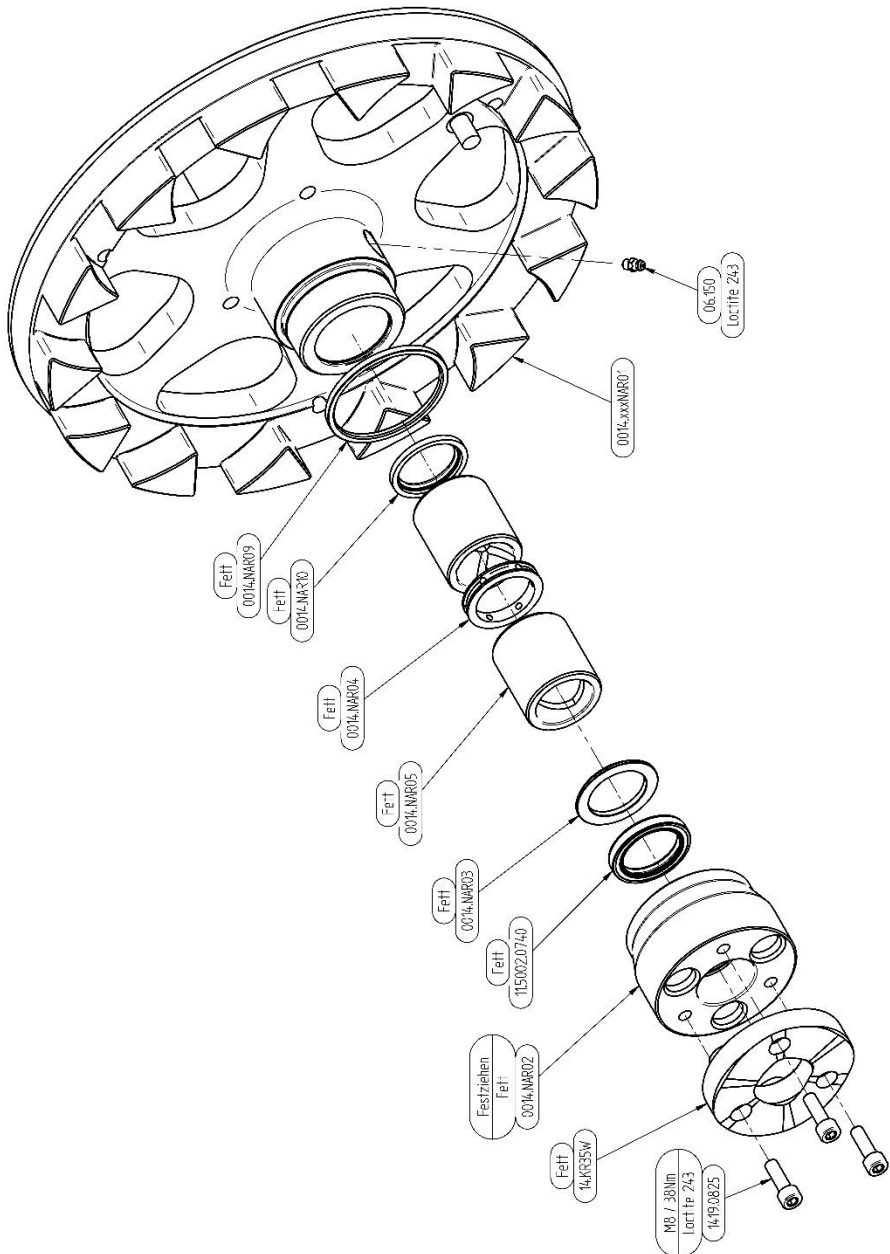


Drawing 2: Explosion 14.2xxR cage

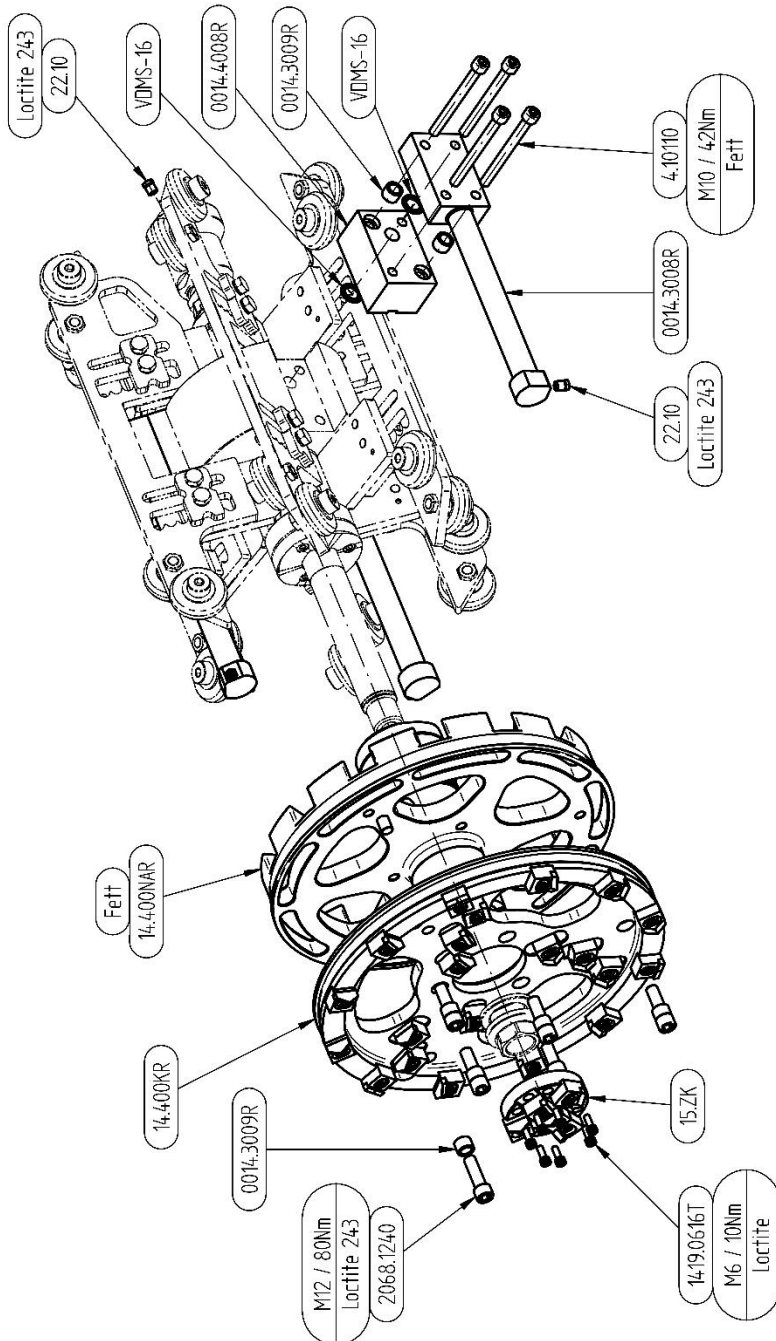
9.2 14.300R-14.450R



Drawing 3: Explosion 14.300-14.450R body



*Drawing 4 Explosion 14.300-14.450R hub*



*Drawing 5: Explosion 14.300-14.450R assembly*



### 9.3 Accessories

#### 9.3.1 Cutting teeth

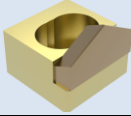
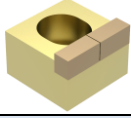
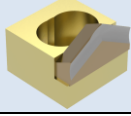
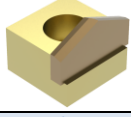

Figure	Article number	Designation	Use
	15.ZU	Universal tooth	14.200R-14.450R
	15.ZHU	Carbide tooth for impact cutter	14.200R-14.450R
	15.ZU-GSL	Impact segment tooth	14.200R-14.450R
	15.Z1	Impact segment tooth for centre	14.200R-14.450R
	15.ZD	Diamond tooth	14.200R-14.450R

Table 12: Accessories, cutting teeth

#### 9.3.2 Hubs

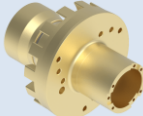


Figure	Article number	Designation	Use
	14.200NAR	Hub for recycling impact milling cutter	14.200R-14.250R
	14.300NAR	Hub for recycling impact milling cutter	14.300R-14.375R
	14.400NAR	Hub for recycling impact milling cutter	14.400R-14.450R

Table 13: Accessories, hubs

## 9.3.3 Centre caps and cutter heads




Figure	Article number	Designation	Use
	15.ZK	Centre cap	14.200R-14.450R
	15.ZKB	Centre cap with bored hole for	14.200R-14.450R
	14.200KR	Impact cutter head with teeth 200 mm	14.200R
	14.225KR	Impact cutter head with teeth 225 mm	14.225R
	14.250KR	Impact cutter head with teeth 250 mm	14.250R
	14.300KR	Impact cutter head with teeth 300 mm	14.300R
	14.350KR	Impact cutter head with teeth 350 mm	14.350R
	14.375KR	Impact cutter head with teeth 375 mm	14.375R
	14.400KR	Impact cutter head with teeth 400 mm	14.400R
	14.450KR	Impact cutter head with teeth 450 mm	14.450R





Table 14: Accessories, centre caps and cutter heads

9.3.4 Diamond crown

Figure	Article number	Designation	Use
	0014.200D	Diamond crown	14.200R
	0014.250D	Diamond crown	14.250R
	0014.300D	Diamond crown	14.300R
	0014.350D	Diamond crown	14.350R
	0014.400D	Diamond crown	14.400R

Table 15: Accessories, diamond crowns

9.3.5 Miscellaneous

Figure	Article number	Designation	Use
	14.K35	Cam plate 3.5 mm with screws	14.200R-14.450R
	1419.0825	Cylinder head screws for cam plate	14.K35W
	0014.2007R	Skid $\varnothing$ 200	14.200R
	0014.2257R	Skid $\varnothing$ 225-250	14.225R-14.250R

	0014.300712R	Skid $\varnothing$ 300 without bracket	14.300R-14.450R
	0014.300722R	Skid $\varnothing$ 300 with bracket	14.300R-14.450R
	0014.30076R	Clamp plate	14.300R-14.450R
	0014.25071R	Skid runner $\varnothing$ 40 mm	14.250R
	0014.00021	Skid runner $\varnothing$ 60 mm	14.300R-14.450R
	14.D80	Spacer	14.200R-14.450R
	0014.NAR11	Lock nut	14.200R-14.450R
	0014.NAR08	Aluminium- bronze washer	14.200R-14.450R
	14.ZSR	Pull rod	14.200R-14.450R
	20141.08SS	Nord-Lock wedge lock washer M8	14.200R-14.450R
	20141.10SPSS	Nord-Lock wedge lock washer M10	14.200R-14.450R

	24.125S	Swivel joint with thrust nozzles	14.200R-14.450R
	14.99001	Torque wrench	
	14.99002	Hexagon wrench socket 3/4"	
	14.99003	Transition piece with magnet 3/4" to 1/2"	
	14.99004	Hand lever grease gun	
	14.99008	Germes 101 grease	
	C191	Oil Spray Bio 500ml	
	C192	Loctite 243 50ml	

Table 16: Diverse accessories

## 10 Directory

### 10.1 Tables

<i>Table 1: Legend 14.250R</i> .....	15
<i>Table 2: Legend 14.300R &amp; 14.4xxR</i> .....	16
<i>Table 3: Legend for technical data</i> .....	16
<i>Table 4: Technical data 14.2xxR</i> .....	17
<i>Table 5: Technical data 14.3xxR</i> .....	18
<i>Table 6: Technical data 14.4xxR</i> .....	19
<i>Table 7: Overview of cutting teeth</i> .....	23
<i>Table 8: Tooth position on the outer ring</i> .....	26
<i>Table 9: Equipping 14.xxxR for calcareous deposits</i> .....	29
<i>Table 10: Equipping 14.xxxR for wood and plastic deposits</i> .....	32
<i>Table 11: Equipping 14.xxxR for concrete deposits</i> .....	35
<i>Table 12: Accessories, cutting teeth</i> .....	65
<i>Table 13: Accessories, hubs</i> .....	65
<i>Table 14: Accessories, centre caps and cutter heads</i> .....	66
<i>Table 15: Accessories, diamond crowns</i> .....	67
<i>Table 16: Diverse accessories</i> .....	69

## 10.2 Figures

<i>Figure 1: Designation of the parts 14.250R .....</i>	<i>15</i>
<i>Figure 2: Designation of the parts 14 300R &amp; 14.4xxR .....</i>	<i>16</i>
<i>Figure 3: Tightening torques 14.2xxR .....</i>	<i>20</i>
<i>Figure 4: Tightening torques 14.3xxR .....</i>	<i>21</i>
<i>Figure 5 Tightening torques 14.4xxR.....</i>	<i>22</i>
<i>Figure 6: Cutting teeth on the centre cap .....</i>	<i>24</i>
<i>Figure 7: Cutting teeth on the inner ring.....</i>	<i>24</i>
<i>Figure 8: Cutting teeth on the outer ring .....</i>	<i>25</i>
<i>Figure 9: Operating principle .....</i>	<i>39</i>
<i>Figure 10: Tooth position «inside» for plastic pipes.....</i>	<i>42</i>
<i>Figure 11: Mounting the diamond crown .....</i>	<i>44</i>
<i>Figure 12: Lubricating nipple.....</i>	<i>45</i>
<i>Figure 13: Disassemble the centre cap.....</i>	<i>45</i>
<i>Figure 14: Mount the centre cap.....</i>	<i>46</i>
<i>Figure 15: Mount the pull rod .....</i>	<i>47</i>
<i>Figure 16: Changing the cutter head .....</i>	<i>49</i>
<i>Figure 17: Set the skids .....</i>	<i>49</i>
<i>Figure 18: Switch the impact off and on .....</i>	<i>51</i>
<i>Figure 19: Changing the nozzle insert.....</i>	<i>54</i>
<i>Figure 20: Changing the cutting tooth.....</i>	<i>55</i>
<i>Figure 21: Change the cam plates.....</i>	<i>58</i>

## 10.3 Drawings

<i>Drawing 1: Explosion 14.2xxR head .....</i>	<i>60</i>
<i>Drawing 2: Explosion 14.2xxR cage .....</i>	<i>61</i>
<i>Drawing 3: Explosion 14.300-14.450R body .....</i>	<i>62</i>
<i>Drawing 4 Explosion 14.300-14.450R hub .....</i>	<i>63</i>
<i>Drawing 5: Explosion 14.300-14.450R assembly .....</i>	<i>64</i>

# 11 Annex

## 11.1 Exclusion of liability

enz® technik ag  
 Schwerzbachstrasse 10      www.enz.com  
 CH-6074 Giswil OW      info@enz.com  
 Tel. +41 41 676 77 66      Fax +41 41 676 77 67



## Disclaimer

---

Customer: .....

.....

.....

enz® technik ag, Schwerzbachstrasse 10, CH-6074 Giswil, represented by

.....

^

rejects any liability in conjunction with the opening of a pipe by milling.

All actions and procedures meet today's standards and are optimally carried out with great care.

The customer is aware that this work can be dangerous, that the pipe can be damaged or even ruined.

By signing below, the customer confirms that he/she has read and understood this disclaimer.

Place and date: .....

enz® technik ag signature:

Customer signature:

.....

.....



## 11.2 Milling project



### Milling cutter project

date: .....

location: .....

period: .....

**truck:**

pressure capacity at pump: .....

flow capacity at pump: .....

1. hose diameter: ..... hose length: .....

2. (Optional) hose diameter: ..... hose length: .....

hose material:  rubber  plastic

water:  fresh water  recycling Water

**pipe:**

pipe material:  concrete  plastic

pipe inside diameter: .....

pipe length: .....

pipe bends?: ..... position: .....

amount of deposits in the pipe: .....

lengths amount of deposits in the pipe: .....

amount of deposits:  0-50%  50-75%  75-100%

water flow direction:  against the current  with the current

slope in percent:  0-5% slope slope % .....

**tools:**

flashlight:  available

flex guide with extension:  available

deflection device for lower edge:  available

tripod with winch:  available

mirror:  available

camera:  available

**IMPORTANT:**

**NEVER USE MILLING CUTTER WITHOUT CONTROLLING WITH CCTV!**

**Flushing pipe before using milling cutter.**

**At least 16" (40cm) in the pipe must be free to be able to insert the milling cutter into the pipe. Otherwise, the deposit should be removed with a pointed hammer so that the milling cutter can be put into the tube.**

## 11.3 Milling project check list



### Checklist milling cutter project

#### Tools

Combination wrench:	17 <input type="checkbox"/>	19 <input type="checkbox"/>	27 <input type="checkbox"/>	36 <input type="checkbox"/>	38 <input type="checkbox"/>	41 <input type="checkbox"/>	71 <input type="checkbox"/>	80 <input type="checkbox"/>
Ratchet set large								<input type="checkbox"/>
Ratchet set small								<input type="checkbox"/>
Box with M4/M6/M8/M10 inserts								<input type="checkbox"/>
Grease gun								<input type="checkbox"/>
Torque wrench up to 200Nm								<input type="checkbox"/>
Torque wrench 10-25Nm								<input type="checkbox"/>
Loctite 243								<input type="checkbox"/>
Motorex Bio Spray								<input type="checkbox"/>

#### Clothing

Helmet								<input type="checkbox"/>
Boots								<input type="checkbox"/>
Warning vest								<input type="checkbox"/>

Wear parts / spare parts	Art. Nr.	Quantity	
Grease	14.99008	1 pcs.	<input type="checkbox"/>
Standard universal milling tooth	15.ZU	10 pcs.	<input type="checkbox"/>
Carbide tooth	15.ZHU	3 pcs.	<input type="checkbox"/>
Screws M8x25	1419.0825	10 pcs.	<input type="checkbox"/>
Screws M8x 16	1419.0816	3 pcs.	<input type="checkbox"/>
Nord Lock washer NL8ss	65212.08	13 pcs.	<input type="checkbox"/>
Cam plate	14.K35W	2 pcs.	<input type="checkbox"/>
Spare rolls Ø40 for IMC 200	0014.25071R	5 pcs.	<input type="checkbox"/>
Spare rolls Ø60 for IMC 300	0014.00021	5 pcs.	<input type="checkbox"/>
Spare screws for Rolls IMC	1359.161220	10 pcs.	<input type="checkbox"/>
Spare washers for Rolls	567.17342	20 pcs.	<input type="checkbox"/>
Spare nuts for Rolls M12 0.5d	124.12	10 pcs.	<input type="checkbox"/>
Pull rod + Center cap IMC	14.ZSR / 15ZKBR	1 pcs.	<input type="checkbox"/>
Reduction bushing M 1¼" F 1"	19.M125F100	1 pcs.	<input type="checkbox"/>
VD sealing ring 1¼"	VDS-20	1 pcs.	<input type="checkbox"/>





A large, dynamic graphic of a water splash or wave, rendered in various shades of blue, occupies the lower half of the page. The water is shown in motion, with many small bubbles and droplets visible, creating a sense of freshness and energy.

enz® technik ag  
Schwerzbachstrasse 10  
CH-6074 Giswil / Switzerland  
Tel. +41 41 676 77 66  
Fax +41 41 676 77 67  
info@enz.com  
www.enz.com