

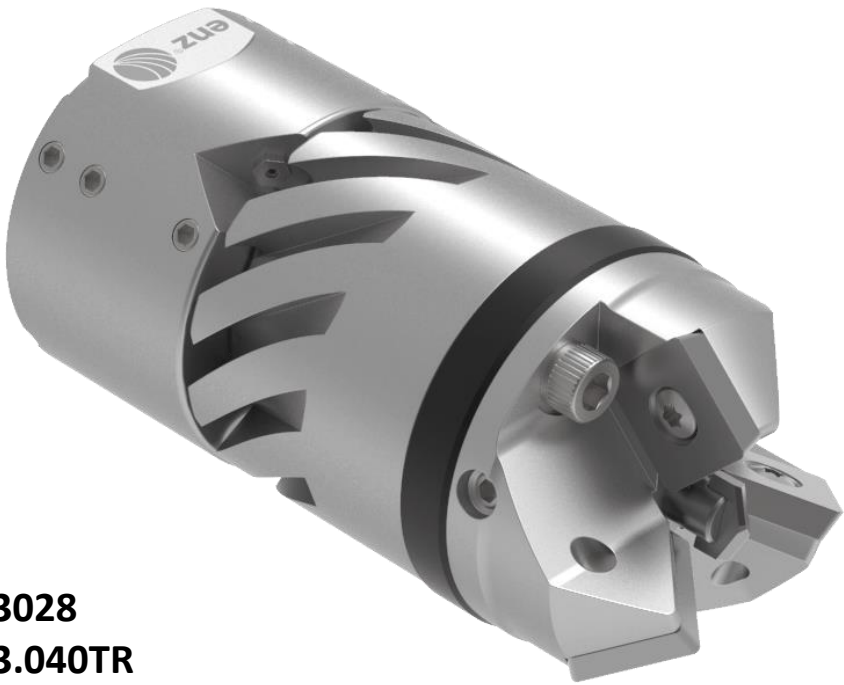

Milling cutter without impact













13028
13.040TR
13.060TR

Operating instructions
English
March 21 | Version 1.1



Table of Contents

| | |
|--|-----------|
| Table of Contents | 2 |
| Preface | 4 |
| Purpose of the document | 4 |
| 1  Safety | 5 |
| 1.1  Consequences when disregarding the safety instructions | 5 |
| 1.2  Target group | 5 |
| 1.3  Requirements on the user | 5 |
| 1.4  Meaning of the general safety instructions | 6 |
| 1.5  Types of instructions in these operating instructions | 6 |
| 1.6  Intended use..... | 7 |
| 1.7  Safety instructions for modifications | 7 |
| 1.8  Personal Protective Equipment (PPE) | 8 |
| 1.9  General safety instructions | 9 |
| 1.10 Applied Standards and Directives..... | 11 |
| 2 Rights | 12 |
| 2.1 Copyright | 12 |
| 2.2 Disclaimer | 12 |
| 2.3 Guarantee conditions | 12 |
| 3 Environment | 13 |
| 3.1 Disposal | 13 |
| 3.2 Environmental protection | 13 |
| 4 Technical data | 14 |
| 4.1 Introduction..... | 14 |
| 4.2 Area of application | 14 |
| 4.3 Designation of the parts | 14 |
| 4.4 Legend for technical data | 14 |
| 4.5 13028..... | 15 |
| 4.6 13.040TR..... | 15 |
| 4.7 13.060TR..... | 15 |
| 5 Installation | 16 |
| 5.1 Equipping..... | 16 |
| 5.2 Assembly of the tools | 16 |
| 5.3 Preparation work..... | 16 |
| 5.4 Setting up the workplace..... | 17 |
| 6 Operation | 18 |
| 6.1 Operating principle..... | 18 |
| 6.2 Operating the product..... | 19 |
| 6.3 Cutting in plastic pipes | 20 |
| 6.4 Concluding work..... | 23 |

6.5 After use 23

6.6 Converting the milling cutter without impact to chain scraper 23

7 Maintenance.....29

7.1 Changing the nozzle inserts..... 29

7.2 Changing the carbide plates 31

7.3 Changing the cutter head 32

7.4 Change the exchangeable centre 36

7.5 Care 36

7.6 Storage 36

8 Spare parts / Accessories.....37

8.1 13028..... 37

8.2 13.040TR..... 38

8.3 13.060TR..... 39

8.4 Accessories 40

9 Directory.....45

9.1 Tables 45

9.2 Figures 45

9.3 Drawings..... 45

10 Notes.....46

| Version | Revision | Date | Signature |
|---------|-------------|-------------|-----------|
| 1.0 | created | January 21 | fkr |
| 1.1 | Supplements | February 21 | bsc |

Preface

Dear customer

Thank you for the trust you have placed in us by the choice of our product. We would be more than pleased to receive any improvement suggestions and any constructive suggestions. We consider your cooperation as contribution to the optimum execution of our product and the documentation.

If you have any questions or suggestions, please contact our customer services directly:

enz® technik ag
Schwerzbachstrasse 10
CH-6074 Giswil / Switzerland

Tel. +41 41 676 77 66
Fax. +41 41 676 77 67
info@enz.com
www.enz.com

Person responsible for the documentation:
Fabian Krasniqi (Tech. Support / Head of QM)

Deviations resulting from product further developments as well as printing errors are reserved.

Purpose of the document

These operating instructions serve to use our product in a comprehensive sense according to its intended use, correctly, effectively and safely. The users are informed about the risks and misuse.



Important!

Read through the original operating instructions before using the product for the first time. Handle accordingly and keep the document in a safe place for future reference.

Carefully read through the operating instructions before working with the cleaning tool. Make sure that it has been understood by all persons working with the product.

The operating instructions should be made available to the operating personnel at all times. If lost, a copy can be requested from your local dealer or direct from the manufacturer. The operating instructions can also be printed out online.

1 Safety

1.1 Consequences when disregarding the safety instructions

Disregarding the safety instructions may lead to accidents with personal injury, property or environmental damage.

The manufacturer is not liable for damage that results from disregarding the safety instructions.

1.2 Target group

These operating instructions are intended for persons that deal with assembly, commissioning or operation of the pipe cleaning tool.

1.3 Requirements on the user

All persons that are involved in the assembly, commissioning or operation of the tool must:

- be familiar with the cleaning work and have respective professional knowledge
- be trained and instructed with regard to use of the product
- have read and understood the operating instructions, in particular the chapter «**Safety**».

Employees without the necessary knowledge must be trained. This can be carried out by the manufacturer of the pipe cleaning tool.

Only the maintenance and repair work described in these operating instructions may be carried out. Other maintenance and repair work must be carried out by the manufacturer.



Observe the instructions in the chapter «**Maintenance**».

1.4 ⚠ Meaning of the general safety instructions

The general safety instructions inform you about potential residual risks which, despite correct use of the product.

To avoid personal injury, property or environmental damage, it is essential that all safety instructions are observed.

1.5 ⚠ Types of instructions in these operating instructions



DANGER!

Designates dangers which, if disregarded, will may result in of death or serious injuries!



WARNING!

Designates dangers which, if disregarded, may result in death, severe injuries or invalidity!



CAUTION!













Designates dangers which, if disregarded, may result in injuries and significant property, financial or environmental damage!



Information for the correct and efficient use of the product.

1.6 Intended use

Due to the high pressures and temperatures, there is a risk of property damage as well as a risk of injury for the user and other persons. For the correct use of the product, the following points must be observed:









-  The product may be used only in pipes or pipe-like channels. The profile to be cleaned must be closed at the top and surrounded by material.
-  The product is suitable for operation in steel, steel and concrete pipes.
-  Consult the manufacturer for use in pipes made of other materials.
-  The product may only be operated with correct hose connections intact.
-  During operation, the cleaning area (shaft, feed, etc.) must be sufficiently secured.
-  During operation, no persons may remain in the pipes or at the ends of the pipes.
-  The max. pressure specified on the product may not be exceeded.
-  The dirty water may not be directed into streams or rivers.
-  Before putting into operation each time, the correct state of the product must be checked.
-  Defects must be rectified before putting into operation.
-  Only flawless tools may be used. (For nuts and bolts, use only matching spanners).
-  Secure hose lines in such a way that they cannot be damaged during operation.
-  Only accessory parts provided and approved by **enz® technik ag** may be used.

1.7 Safety instructions for modifications

It is forbidden to carry out individual conversions or modifications to the pipe cleaning tool. Only parts authorised by the manufacturer may be used. The manufacturer is not liable for damage that results in conjunction with conversions on product made at your own authority.

1.8 ⚠️ Personal Protective Equipment (PPE)

Wearing personal protective equipment (PPE) cannot eliminate dangers. PPE can however reduce or eliminate the impacts of dangers. Accidents and occupational illnesses are avoided.

| | |
|---|-------------------------------|
|  | <h3>Breathing protection</h3> |
|  | <h3>Harness</h3> |
|  | <h3>Protective clothing</h3> |
|  | <h3>Protective apron</h3> |
|  | <h3>Suitable shoes</h3> |
|  | <h3>Hand protection</h3> |
|  | <h3>Hard hat</h3> |
|  | <h3>Face protection</h3> |

Isolation device (breathing apparatus) for remaining in dangerous atmospheres and for rescue operations. Isolation devices for self-rescue (self-contained open-circuit compressed air breathing apparatus and regenerative devices) for remaining in channels and for first supply of persons injured.

Rescue harness or safety clothing with sewn-in neck eyelet. During the rescue operation, the rescue rope is attached to the neck eyelet. Lifting the injured person is carried out, e.g. By means of a rescue lifting device with automatic load backstop.

Closed work clothing that protects against water jets, contamination of skin and possible infections.

At pressure ranges higher than 800 bar, a protective apron provides additional protection.

The safety shoes should, in particular, offer good support, anti-slip and leak proof as well as protect against water jets. At pressure ranges higher than 800 bar, gaiters provide additional protection.

Suitable gloves protect against hand injuries, contact against substances hazardous to health and contaminated water.

The hat protects the persons head against falling objects as well as against knocking against fixed objects.

A suitable face protection protects against water jets and contamination.



Ear protection

For noise, e.g. ear protector capsules with integrated headset can be worn.



Eye protection

If there is a danger by splitters, splashing of hazardous substances, etc. eyes must be protected.



Gas detector

In event of poisonous vapours and risk of explosion (methane) in work the area, a suitable gas detector may be useful.



Network-independent lighting

A splash-proof torch or a lamp fixed to a hard hat must be carried.



Hose guard

With pressure ranges higher than 800 bar, a suitable hose guard (e.g. Made of Kevlar) provides additional protection against water jets.

1.9 ⚠️ General safety instructions

Danger! | High-pressure water jets



Defective products or incorrect operation of the product increases the dangers from splash water under pressure. Before operation, ensure the trouble-free state of the product. Powerful water jets may cause heavy injuries or even sever limbs. Non-observance of the safety instructions may result in death or very serious injuries!

Danger! | Poisonous substances



Channels, pipes and tanks may contain poisonous vapours. Wear the prescribed protective equipment such as gas masks, gas alarms and rescue harnesses. Inhaling poisonous vapours or air contaminated with particles may result in death or very serious injuries!



Danger! | Suspended load

In the working environment, there is a danger by suspended loads such as tools or objects to be cleaned. Never stand under suspended loads. Death or very serious injuries may result from objects falling down!



Danger! | Falling objects

In the area of open shafts, objects may fall in. When inserting the product, never remain directly under the shaft opening. Secure the shaft access against parts that fall down. Do not throw any tools or objects into the shaft. Never access shafts that are in danger of collapsing. Persons could be buried. Non-observance of safety instructions may result in death or serious injuries!



Warning! | Corrosive substances

Channels, pipes and tanks may contain corrosive or other harmful substances. Wear the respective protective clothing.. Use the prescribed protective equipment. Chemical burns to skin skin and eyes or infections may be the consequence!



Warning! | Explosive materials

Channels, pipes and tanks may contain explosive substances. Use a gas detector in order to detect these. Sparks may be generated when working with Enz tools. This may result in severe injury and property damage.



Warning! | Risk of falling

In the area where work is carried out using the product, open shafts are to be expected. Open shafts must be indicated. Take care where you step. Falling may result in death or very serious injuries!



Warning! | Hand injuries

With a modification of the product, there is a risk of hand injuries. Wear gloves when working. Pay attention to where you hold the product. Carry heavy devices with the assistance of a second person. If not observed, this may result in crushing, abrasion up to the severing of limbs!

**Caution! | Tipped objects**

With a modification of the product, there is a risk of hand injuries from sharp edges. Wear gloves when working. Pay attention to where you hold the product. If not observed, this may result in cut injuries!

**Caution! | Risk of falling**

In the area where work is carried out with the product, lines and objects are to be expected on the ground. Take care where you step. Keep the operating area clean and tidy. Falling caused by tripping may result in injury!

**Caution! | Hot surfaces**

The product may heat strongly during operation. This can result in burns!

1.10 Applied Standards and Directives

- Machinery Directive: 2006/42/EC
- EN1829-1:2018 High-pressure water jet machines - Safety requirements - Part 1: Machines
- EN1829-2:2008 High-pressure water jet machines - Safety requirements - Part 2: Hoses, hose lines and connectors
- EN ISO 4413:2010 Hydraulic fluid power - General rules and safety requirements for systems and their components
- Recommended procedure for the use of high-pressure water jet devices (WJTA-IMAC)
- Recommended procedure for high-pressure water jets (WJA)
- Industrial Cleaning Foundation Industrielle Reinigung (The Netherlands)
- – SIR

2 Rights

2.1 Copyright

This manual may not be partially or completely copied, photocopied, reproduced, translated or converted in an electronically of machine-readable form without the prior written consent of **enz® technik ag**.

©2021 enz® technik ag, CH-6074 Giswil.

All rights reserved.

2.2 Disclaimer

The manufacturer is not liable for damage that:

- has resulted in conjunction with modifications to the product carried out at your own authority.
- have resulted from disregarding the safety instructions.

2.3 Guarantee conditions

In line with our terms of sales and delivery, we issue a guarantee. However, the guarantee is omitted:

- When used under conditions stipulated otherwise by us.
- When using replacement or accessory parts that are not original from **enz® technik ag**.
- In event of damage caused by:
 - Incorrect use
 - Non-observance of the operating instructions
 - Unsuitable operating material
 - Routing of the hose or pipelines incorrectly or inappropriately
 - modifications or conversions to the product at your own authority.

3 Environment

3.1 Disposal

Old devices have valuable recyclable materials that should be recycled. Therefore, please dispose of old devices via enz® technik ag or at suitable collecting points.

3.2 Environmental protection

Please observe that surfaces can only be cleaned where the composition of the contamination known. Chemicals or other poisonous substances must never be released to the environment. Take care to avoid excessive use of water. In this way, you help to protect natural resources.

4 Technical data

4.1 Introduction

The enz[®] cutters without impact are suitable for operation with fresh water (13.028) and recycling water (13.040TR and 13.060TR). The cutter heads are equipped with carbide plates which are suitable for different deposits. Worn carbide plates can be replaced without any problem. For cutting in plastic pipes, additional wear resistant rings are mounted to ensure that the plastic pipe is not damaged.

4.2 Area of application

- Cutting concrete and concrete slurry
- Cutting of mineral deposits
- Removal of roots

4.3 Designation of the parts

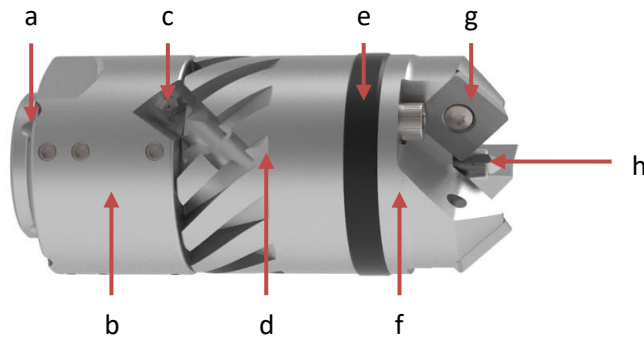

Figure 1: Designation of the parts

4.3.1 Legend

- | | | |
|--------------------|----------------|------------------------|
| a: Thrust nozzle | d: Rotor | g: Carbide plate |
| b: Connecting part | e: Wear ring | h: Exchangeable centre |
| c: Drive nozzle | f: Cutter head | |

4.4 Legend for technical data

| | | | |
|--|----------------------------|--|---------------------------|
| | Connecting thread [“] | | Rotating nozzles / bore |
| | Mass | | Thrust jet |
| | Maximum operating pressure | | Area of application |
| | Can be recycled | | min. flow rate at 100 bar |

Table 1: Legend for technical data

4.5 **13028**



| Order no. | | | | | | | ØxL | | | | | |
|-----------|--------------|----------|----------|---|----|------|-------|---------|-------|--------|-----|-------|
| | | | | | mm | inch | mm | inch | l/min | US gpm | bar | psi |
| 13028 | BSPG 1/4" | 3x M4 | 3x M4 | - | 30 | 1.2 | 28x81 | 1.1x3.2 | 20 | 5.3 | 350 | 5,000 |

Table 2: Technical data 13.028

4.6 **13.040TR**



| Order no. | | | | | | | ØxL | | | | | |
|-----------|--------------|----------|----------|---|-----------|-------------|--------|---------|-------|--------|-----|-------|
| | | | | | mm | inch | mm | inch | l/min | US gpm | bar | psi |
| 13.040TR | BSPG 1/2" | 2x M6 | 4x M6 | ✓ | 42- 60 | 1.7- 2.4 | 40x108 | 1.6x4.3 | 30 | 7.9 | 250 | 3,600 |

Table 3: Technical Data 13.040TR

4.7 **13.060TR**

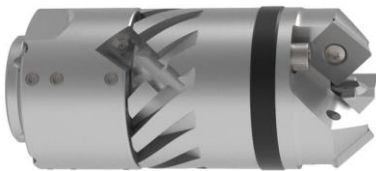

| Order no. | | | | | | | ØxL | | | | | |
|-----------|------------|----------|----------|---|-----------|-------------|--------|---------|-------|--------|-----|-------|
| | | | | | mm | inch | mm | inch | l/min | US gpm | bar | psi |
| 13.060TR | BSPG 1" | 2x M6 | 4x M8 | ✓ | 62- 80 | 2.4- 3.1 | 60x130 | 2.4x5.1 | 50 | 13.2 | 250 | 3,600 |

Table 4: Technical Data 13.060TR

5 Installation

5.1 Equipping

To match the milling cutter without impact optimally to the pump, enz[®] technik ag needs the following parameters for each order:

- | | | |
|---------------------|------------|--------|
| • Pumping capacity: | l/min | US gpm |
| • Pump pressure: | bar | psi |
| • Hose diameter: | mm inch | |
| • Hose length: | m | feet |
| • Hose material: | Plastic | Rubber |
-



If the parameters change, the tool must be matched again.

5.2 Assembly of the tools

The milling cutter without impact is supplied ready for operation. After unpacking, check that the delivery is complete. Then the milling cutter without impact is screwed onto the high-pressure hose.

As standard, the tool rotates clockwise. This means that it cannot be disconnected from the hose during operation.

The exception is formed by the milling cutter without impact 13.028, this is driven differently and is rotated counter-clockwise as standard.

5.3 Preparation work

Knowledge of the following points are useful for the preparation and setting of the tool:

- Pipe run
- Internal diameter of the pipe to be processed
- Material quality of the pipe to be processed
- Type of contamination in the pipe
- Access possibilities to the pipe

5.4 Setting up the workplace

Before starting work, the following measures must be taken:

- ⚠ Install any barriers and protective equipment (Triopan warning sign, fencing ropes, etc.).
- ⚠ Obtain the necessary information about the waste water introduced to the pipe (chemical substances, gases, vapours, etc.).
- ⚠ The necessary measuring devices such as explosimeter, oxygen meter, gas alarm, etc. must be ready for use.
- ⚠ The working area must be cordoned off such that there is no danger for other persons.
- ⚠ Make sure that the nozzles suitable for cleaning the pipe are present. The area of application of each nozzle is apparent in chapter **4 Technical data**.
- ⚠ The pipe run (plans) must be known before starting work in order to prevent the nozzle from exiting at the end of the line. Possible exit location must be monitored by support staff.
- ⚠ The surface of the workplace must be clean and have sufficient grip, loose obstructions at the workplace must be removed.
- ⚠ Ensure that on workplace is sufficiently illuminated.
- ⚠ The workplace must be dimensioned such that the operator has sufficient freedom of movement and can assume a safe working posture.
- ⚠ The workplace must ensure that water can drain or run away.
- ⚠ Scaffolding must be setup in a stable manner and secured against tipping, moving and falling over.
- ⚠ Work platforms must be setup in a stable manner. They must not move when carrying out cleaning work.
- ⚠ Scaffolding and work platforms must comply with regards to the standards on occupational protection and may only be installed by trained specialist personnel.
- ⚠ Loose parts to be cleaned must be secured before commencing work.

6 Operation

6.1 Operating principle

The thrust nozzles (1) on the connecting part (2) ensure for sufficient tractive power and press the milling cutter without impact on to the deposits. The drive nozzles (3) drive the turbine-like rotor (4). Up to 3 carbide plates (6) and an exchangeable centre (7) are mounted on the cutter head (5) which efficiently cut away deposits.

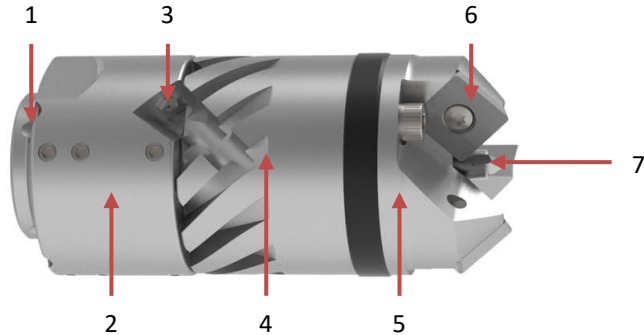

Figure 2: Operating principle 13.060TR

6.2 Operating the product

1. Before cutting with standard nozzle, completely rinse the loose stones out of the pipe. Loose stones may impair work and damage the carbide plates of the milling cutter without impact.
2. Check the condition of the pipe using a camera and prepare an as-is survey.
3. Push the milling cutter without impact into the pipe to be cleaned by at least half of its length.
4. Allow the milling cutter without impact to start-up with approx. 50- 80 bar and guide it up to the deposits.
5. Slowly increase the pressure on the milling cutter without impact to 100 bar. In normal cases, the pipe can be efficiently cleaned with this pressure.
6. Perform work with the high-pressure hose in your hand and feel the vibrations. As soon as you no longer feel any vibrations, pull the milling cutter without impact back a little in order to slowly feed it back to the deposits again.
7. Monitor work regularly using a camera.
8. For a good result after cutting, clean the pipe all around using a rotary nozzle or chain scraper.
9. Close all shaft covers after completing work.



CAUTION!

The milling cutter without impact may only be used in pipes installed in a straight line. Otherwise this may result in significant property damage.



CAUTION!

Always use the matching cutter diameter for the respective pipe. Otherwise damage may be caused to the pipe wall and tool.



CAUTION!

Never allow the milling cutter without impact to jump (pulling the hose back manually and then letting go)! Otherwise this may result in damage to the pipe and tool.



If possible, always work in the direction of flow in order not to interrupt the flow of water in the channel.



For the removal of thick roots, the milling cutter without impact can be converted to a chain scraper. See chapter **6.6 Converting the milling cutter without impact** to chain scraper.



When pulling the milling cutter without impact back, continue to allow water to flow with low pressure. This prevents dirty water running into the inside of nozzle through the nozzle inserts.

6.3 Cutting in plastic pipes

For cutting in plastic pipes, for milling cutters without impact (models 13.040TR and 13.060TR), a wear resistant ring and a wear ring for plastic pipes must be mounted. Otherwise the plastic pipe will be damaged.

6.3.1 Converting 13.040TR for plastic pipes

1. Heat the rotor (Art. no. 0010.0603TR) next to the wear ring (Art. no. 0013.0404TR) with a gas torch (C158) for approx. 10 seconds. Loosen the milling cutter head (Art. no. 0013.0405TR) using a spanner WAF 36.
2. Replace the wear ring with the wear ring for plastic pipes (Art. no. 0013.0404TR-48). Check the O-ring (Art. no. OR32.0150) on the milling cutter head; replace it if necessary. Coat the thread of the milling cutter head with Loctite 243 (C192).
3. Tighten the milling cutter head with a spanner WAF 36.
4. Heat the threaded pin (Art. no. 617.0605) with a gas torch (C158) for 10 seconds. Loosen the threaded pin using an Allen key WAF 3.

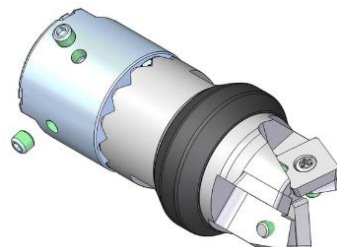
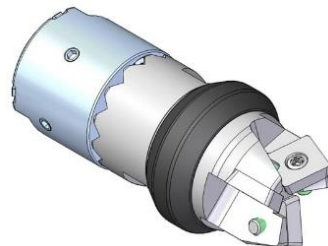

5. Push the wear resistant ring (Art. no. 0013.0407TR-48) on to the connecting part.
6. Apply Loctite 243 (C192) to the thread of the four oval head screws (Art. no. 1593.0606). Tighten these with an Allen key WAF 3.
7.  Leave the Loctite to dry for at least 24 hours at room temperature.

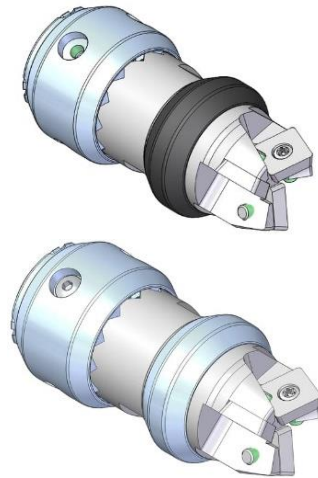
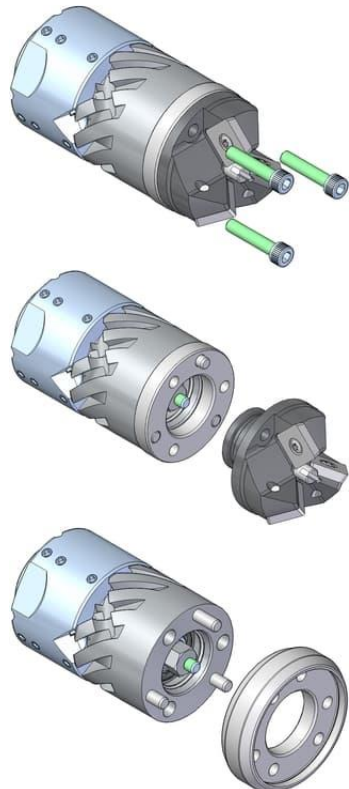

Figure 3: Converting milling cutter 13.040TR for plastic pipes

6.3.2 Converting 13.060TR for plastic pipes

1. Loosen the three cylinder head screws (Art. no. 1419.0630) using an Allen key WAF 5.
2. Remove the milling cutter head (Art. no. 0013.0605TR)
3. Replace the standard wear ring (Art. no. 0013.0604TR) with the wear ring for plastic pipes (Art. no. 0013.0604TR-68).



4. Check the O-ring (Art. no. OR28.0200) on the milling cutter head; replace it if necessary. Place the milling cutter head on the milling cutter. Coat the thread of the cylinder head screws with Loctite 243 (C192). Tighten the screws using an Allen key WAF 5.

! M=15 Nm.

5. Loosen the four 12 threaded pins head screws (Art. no. 617.0605) in the middle using an Allen key WAF 3.

6. Push the wear ring (Art. no. 0013.0607TR-68) on to the connecting part.

7. Coat the thread of the four oval head screws (Art. no. 1593.0606) with Loctite 243 (C192). Tighten these with an Allen key WAF 3.

8. ! Leave the Loctite to dry for at least 24 hours at room temperature.

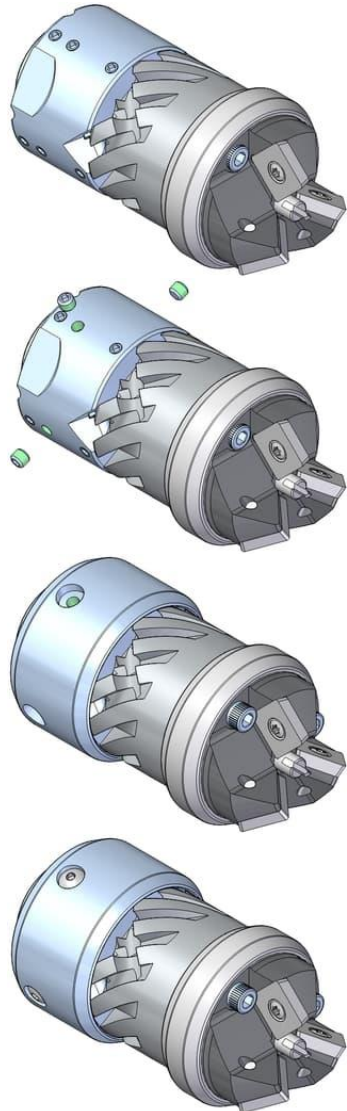

Figure 4: Converting milling cutter 13.060TR for plastic pipes

6.4 Concluding work

After finishing the cutting work, check the pipes cleaned using a camera. In doing so, pay particular attention to damage on the pipe as well as liquids leaking to the environment. Close all shaft covers when finished.

6.5 After use

Follow the following steps in order to guarantee the functionality when cutting without impact at all times:

1. Rinse the milling cutter without impact after use with fresh water. Dry it.
2. Check the carbide plates for signs of wear, replace the work carbide plates (for the models 13.040TR and 13.060TR). See chapter **7.2 Changing the** carbide plates.
3. Preserve the milling cutter without impact using Oil Spray Bio (C191).

6.6 Converting the milling cutter without impact to chain scraper

The milling cutter without impact can be converted to chain scraper. Follow the following steps:

6.6.1 Converting 13.028 to chain scraper

More information on the assembly of links and pin bolt chains can be obtained under: <https://www.enz.com/de/produktesupport/downloadcenter?cPage=1>

1. Loosen the two cylinder head screws (Art. no. 3.0406T) on milling cutter head (Art. no. 0010.0285M) using an Allen key WAF 3.

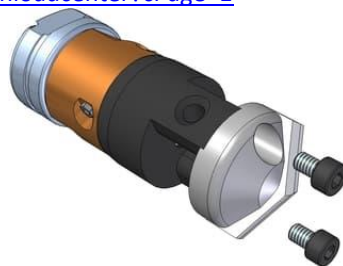

2. Remove the milling cutter head.

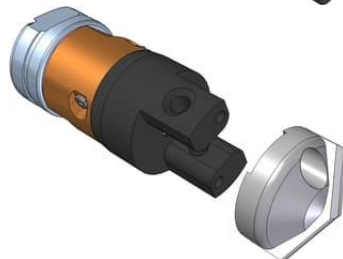

3. Place the matching link chain (Art. no. 0010.028050K, 0010.028075K or 0010.028100K) in the middle of the mounting. Coat the threaded pin (Art. no. 617.0612) with Loctite 243 (C192). Tighten these uniformly with an Allen key WAF 3.
4. Place the cover (Art. no. 0010.0285) on the milling cutter. Tighten the screws. For screws without Tuflok, use Loctite 243 (C192).
5. Press the ball cage (Art. no. 0010.0286) onto the stator until it engages.
6.  Leave the Loctite to dry for at least 24 hours at room temperature.

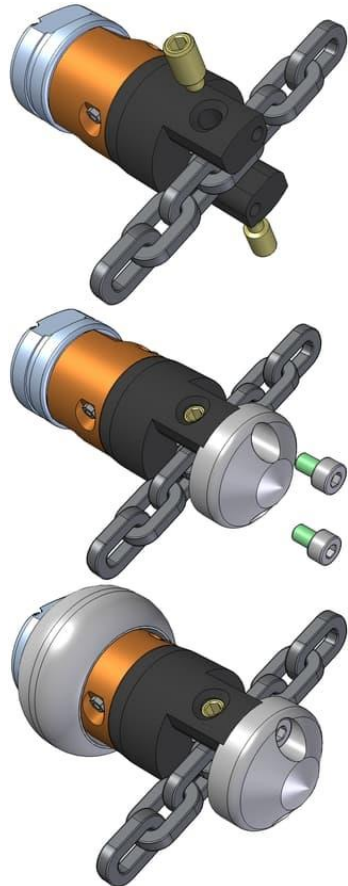
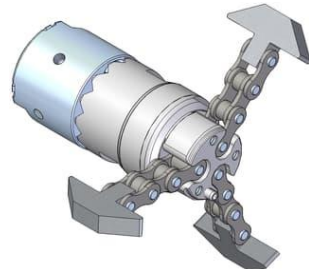
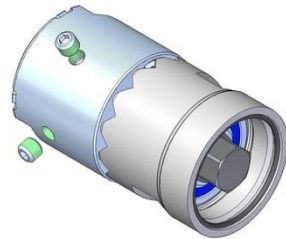
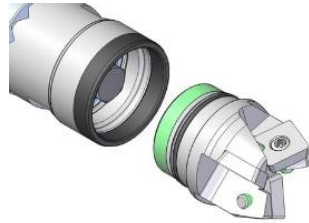

Figure 5: Converting 13.028 to chain scraper

6.6.2 Converting 13.040TR to chain scraper

More information on the assembly of links and pin bolt chains can be obtained under:
<https://www.enz.com/de/produktesupport/downloadcenter?cPage=1>

1. Heat the rotor (Art. no. 0010.0603TR) next to the standard wear ring (Art. no. 0013.0404TR) with a gas torch (C158) for 10 seconds. Loosen the milling cutter head (Art. no. 0013.0405TR) using a spanner WAF 36.
2. Remove the standard wear ring.
3. Loosen the threaded pin (Art. no. 617.0605) using an Allen key WAF 3.
4. Check the O-ring (Art. no. OR32.0150) on the chain holder, replace it if necessary. Coat the thread of the chain holder (Art. no. 0010.0604TR) with Loctite 243 (C192). Tighten the chain holder with a spanner WAF 36.
5. Place the matching pin bolt chains (Art. no. 0010.060060G, 0010.060075G, 0010.060100G, 0010.060125G, 0010.060150G or 0010.060200G) into the recesses of the chain holder.



6. Place the cover with root cutter (0010.0605TRM) onto the chain holder. Tighten the three Tuflok cylinder head screws (Art. no. 1419.0510T). For screws without Tuflok, use Loctite 243 (C192).

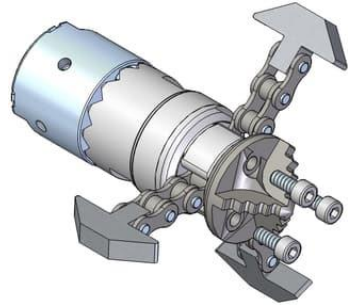

7. Push the cage ring (Art. no. 0010.0607TR) on to the connecting part. Coat the thread of the two cylinder head screws (Art. no. 3.0606) with Loctite 243 (C192). Tighten the screws. Apply Loctite to two threaded pins. Screw these into the open tapped holes.

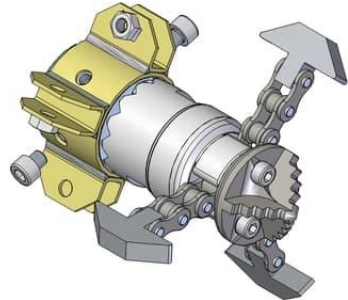

8. Mount four plastic skids that match the pin bolt chain (Art. no. 0010.060710TR, 0010.060712TR, 0010.060715TR or 0010.060720TR). Tighten the four hexagon head bolts (Art. no. 56.0616).

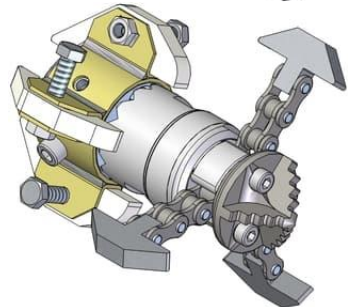

9.  Leave the Loctite to dry for at least 24 hours at room temperature.

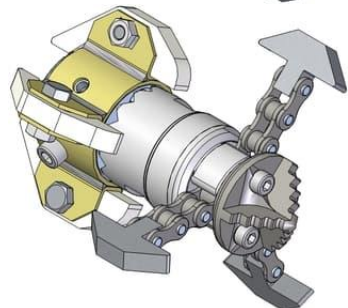
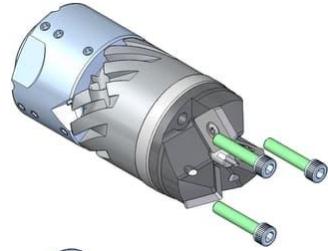

Figure 6: Converting 13.040TR to chain scraper

6.6.3 Converting 13.060TR to chain scraper

More information on the assembly of links and pin bolt chains can be obtained under:
<https://www.enz.com/de/produktesupport/downloadcenter?cPage=1>

1. Loosen the three cylinder head screws (Art. no. 1419.0630) using an Allen key WAF 5.



2. Remove the milling cutter head (Art. no. 0013.0605TR)

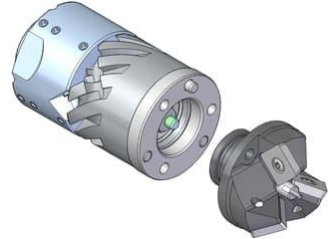

3. Remove the standard wear ring. (Art. no. 0013.0604TR).

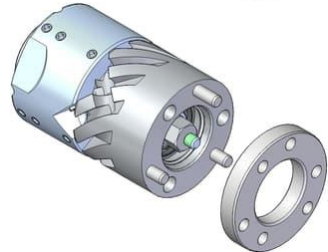

4. Loosen the four 12 threaded pins (Art. no. 617.0605) in the middle on the connection part using an Allen key WAF 3.

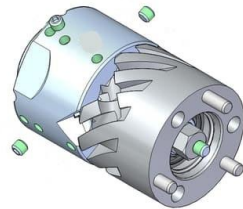

5. Check the O-ring (Art. no. OR28.0200) on the chain holder, replace it if necessary. Mount the chain holder (Art. no. 0010.1255TR) onto the rotor.

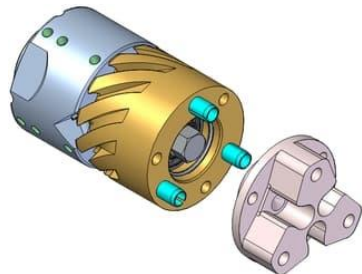

6. Place the matching pin bolt chains (Art. no. 0010.125100G, 0010.125125G, 0010.125150G, 0010.125200G, 0010.125225G, 0010.125250G or 0010.125300G) into the recesses of the chain holder.

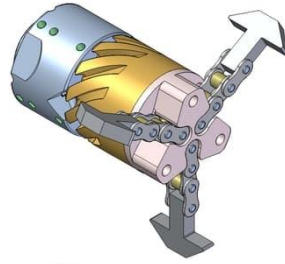

7. Place the root cutter (Art. no. 0010.1254TR) onto the chain holder. Tighten the three Tuflok hexagon head bolts (Art. no. 57.0640T). For screws without Tuflok, use Loctite 243 (C192).

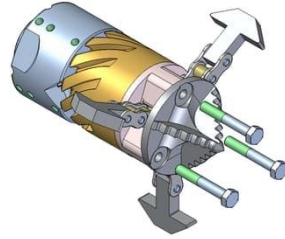

! M=10 Nm.

8. Push the cage ring (Art. no. 0010.1257TR) on to the connecting part. Coat the thread of the four oval head screws (Art. no. 1593.0608) with Loctite 243 (C192). Tighten the crews using an Allen key WAF 3.

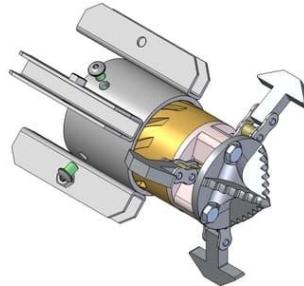

9. Mount four plastic skids that match the pin bolt chain (Art. no. 0010.125710TR, 0010.125712TR, 0010.125715TR, 0010.125720TR, 0010.125722TR, 0010.125725TR or 0010.125730TR). Tighten the four hexagon head bolts (Art. no. 622.0620).

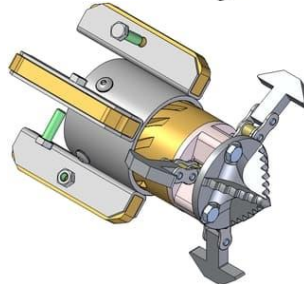

10. ! Leave the Loctite to dry for at least 24 hours at room temperature.

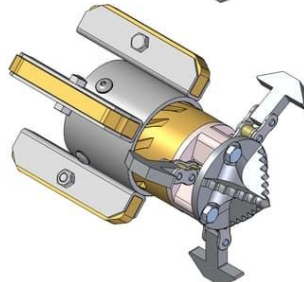

Figure 7: Converting 13.060TR to chain scraper

7 Maintenance

The maintenance and repair activities described in these operating instructions may only be carried out by users who have the necessary knowledge.

7.1 Changing the nozzle inserts

To guarantee an optimum cleaning performance, the nozzle inserts must be checked visually for damage after being used each time. The wear depends on the degree of contamination of the water used.



CAUTION!

Worn nozzle inserts impair the cleaning performance. There is an increased danger when the pressure increases. This can result in damage to the tool.

Relocating: To determine the matching nozzle inserts (Art. no. 22.04 for 13.028, 22.06 for 13.040TR, 22.06/22.08 drive / thrust for 13.060TR), use JetCalc.

When changing the nozzle inserts, follow the following steps:

1. During the approx. 10 seconds, heat the nozzle inserts with the gas torch (C158).
2. Disassemble the nozzle insert using the socket spanner WAF 7 (C160 or C260).
3. Clean / degrease the threaded hole and the new nozzle insert, e.g. with acetone.

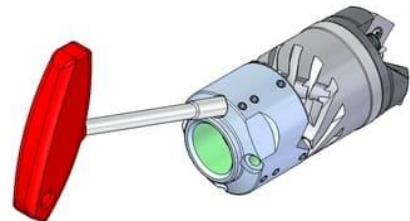

4. Coat the thread of the nozzle insert with Loctite 243 (C192).
5. Mount the nozzle insert using the socket spanner SW 7.
6.  Leave the Loctite to dry for at least 24 hours at room temperature.

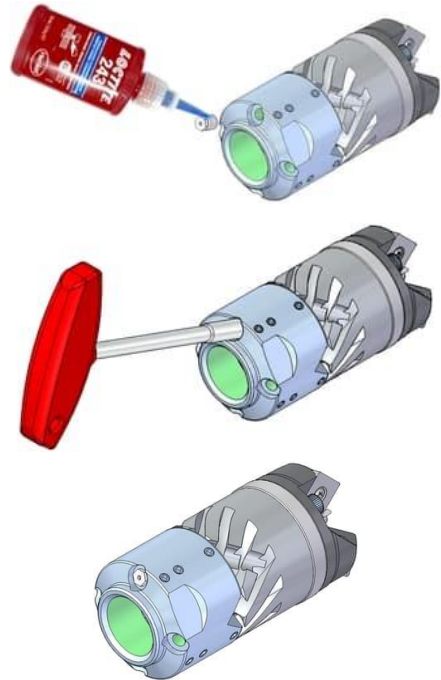

Figure 8: Changing the nozzle insert



CAUTION!

The nozzle inserts must be replaced by identical nozzle inserts. The nozzle diameter influences the speed and tractive force.



CAUTION!

Never use a pliers with teeth. These may damage the tool or the hose. This may lead to the tool bursting during operation.



The nozzle inserts and the female thread on the tool must be clean, dry and free from oil and grease. Impurities impair the properties of the adhesive.

7.2 Changing the carbide plates

If the carbide plates (13.040TR: Art. no. 16.16ZW; 13.060TR: Art. no. 16.19ZW) are worn, the cutting performance decreases. They must therefore be replaced every now and then.

Follow the following steps:

1. Loosen the screws (13.040TR: Art. no. FS242; 13.060TR: Art. no. FS1010) using a Torx key T20.

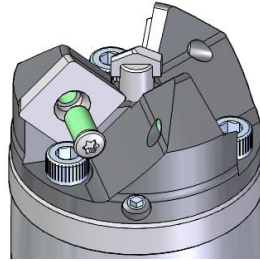

2. Remove the worn carbide plate.

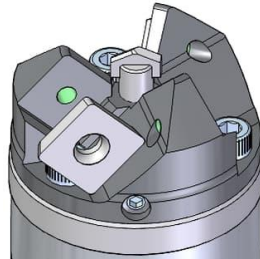

3. Position the new carbide plate on the surface cleaned.

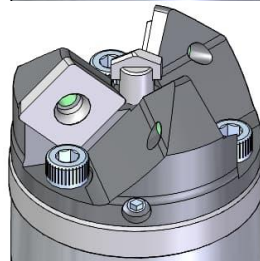

4. Coat the thread of the screw with Loctite 243 (C192). Tighten these with a Torx key T20.

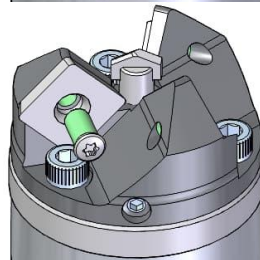

5.  Leave the adhesive to dry for at least 24 hours at room temperature.

Figure 9: Changing the carbide plates

7.3 Changing the cutter head

7.3.1 13028

1. Loosen the two cylinder head screws (Art. no. 3.0406T) using an Allen key WAF 3.

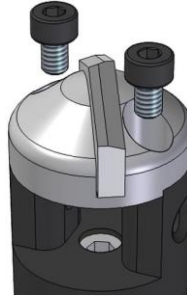

2. Remove the cover (Art. no. 0010.0285M) Clean the support surface and thread on the milling cutter.

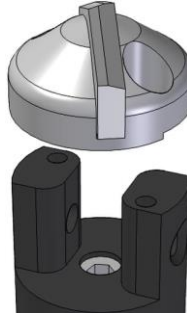

3. Place the new cover on the milling cutter. For screws without Tuflok, use Loctite 243 (C192).

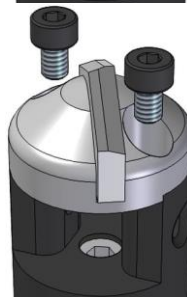

4. Tighten the cylinder head screws.

5.  Leave the adhesive to dry for at least 24 hours at room temperature.

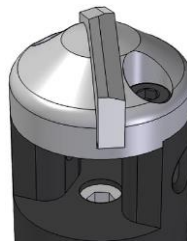

Figure 10: Change milling cutter head 13.028

7.3.2 13.040TR

1. Loosen the milling cutter head (Art. no. 0013.0405TR) using a spanner WAF 36.



2. Replace with standard wear ring (Art. no. 0013.0404TR) with a new one.



3. Check the O-ring (Art. no. OR32.0150) on the milling cutter head, replace it if necessary. Coat the thread of the new milling cutter head with Loctite 243 (C192).

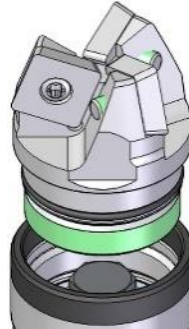

4. Tighten the head with a spanner WAF 36.

 Leave the adhesive to dry for at least 24 hours at room temperature.

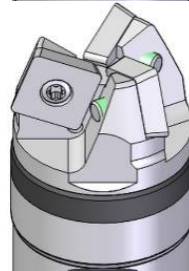
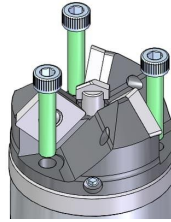

Figure 11: Change milling cutter head 13.040TR

7.3.3 13.060TR

1. Loosen the three cylinder head screws (Art. no. 1419.0630) using an Allen key WAF 5.



2. Remove the old head (Art. no. 0013.0605TR).

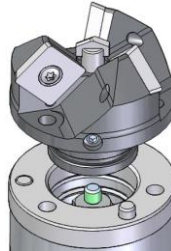

3. Remove the standard wear ring. (Art. no. 0013.0604TR).

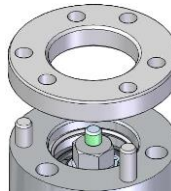

4. Replace the three cylinder pins (Art. no. 684.0625).

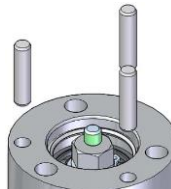

5. Mount the new standard wear ring.

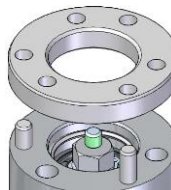

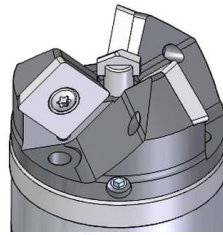

6. Check the O-ring (Art. no. OR28.0200) on the milling cutter head, replace it if necessary. Place the new head on the milling cutter.

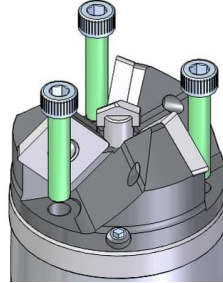

7. Coat the thread of the cylinder head screws with Loctite 243 (C192). Tighten these with an Allen key WAF 5.

 M=15 Nm.



8.  Leave the adhesive to dry for at least 24 hours at room temperature.

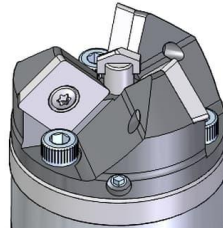



Figure 12: Change milling cutter head 13.060TR

7.4 Change the exchangeable centre

1. Loosen the threaded pin (Art. no. 619.0625) using an Allen key WAF 3.
2. Remove the exchangeable centre (Art. no. 0013.0606TR).
3. Mount the new exchangeable centre with the flat side towards the opening for the threaded pin.
4. Apply a coat of Loctite 243 (C192) to the threaded pin and screw tight.
5.  Leave the adhesive to dry for at least 24 hours at room temperature.

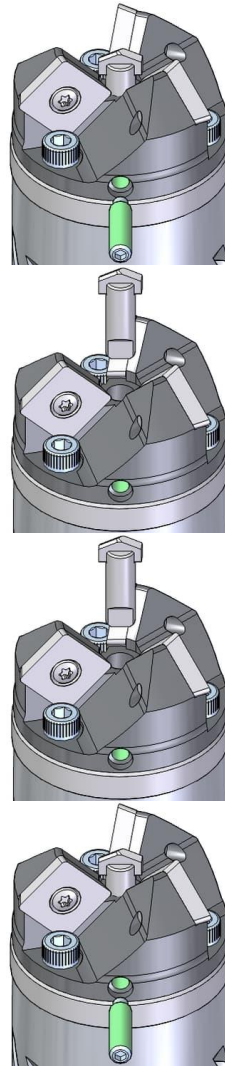

Figure 13: Change the exchangeable centre

7.5 Care

The milling cutter without impact must be thoroughly cleaned after being used each time. After cleaning, it must be preserved with Motorex Oil Spray Bio (C191).

7.6 Storage

The milling cutter without impact must be stored in a dry location protected from dust. We recommend using a plastic container with lid.

8 Spare parts / Accessories

8.1 13028

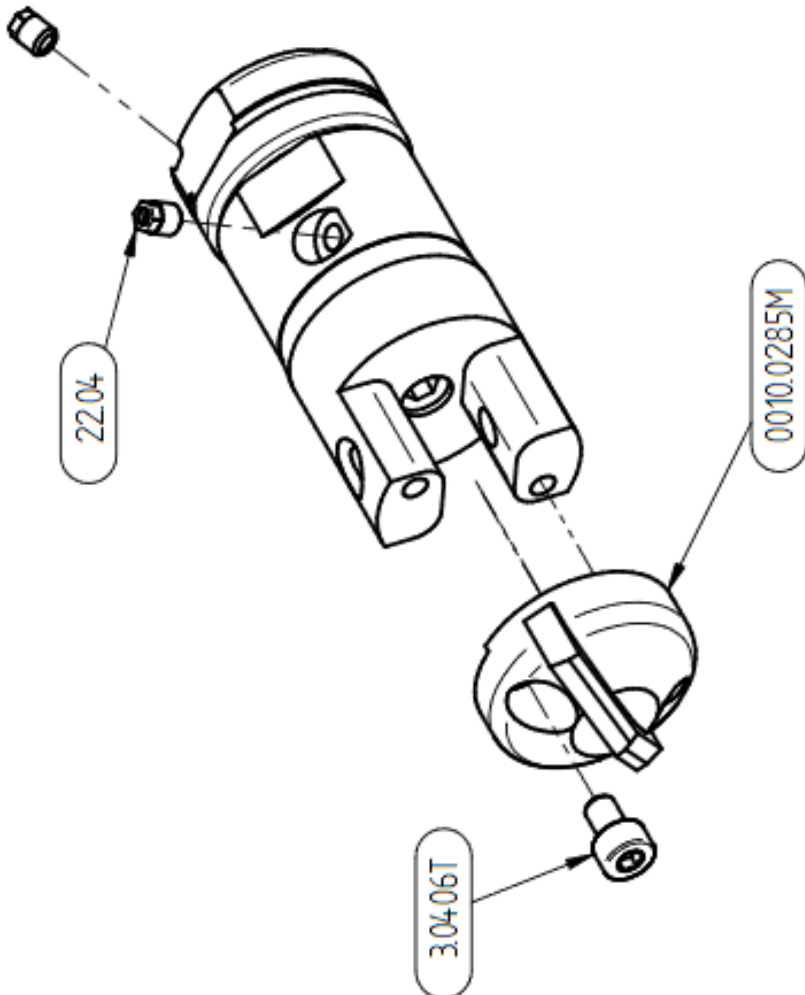

Drawing 1: Explosion 13.028

8.2 13.040TR

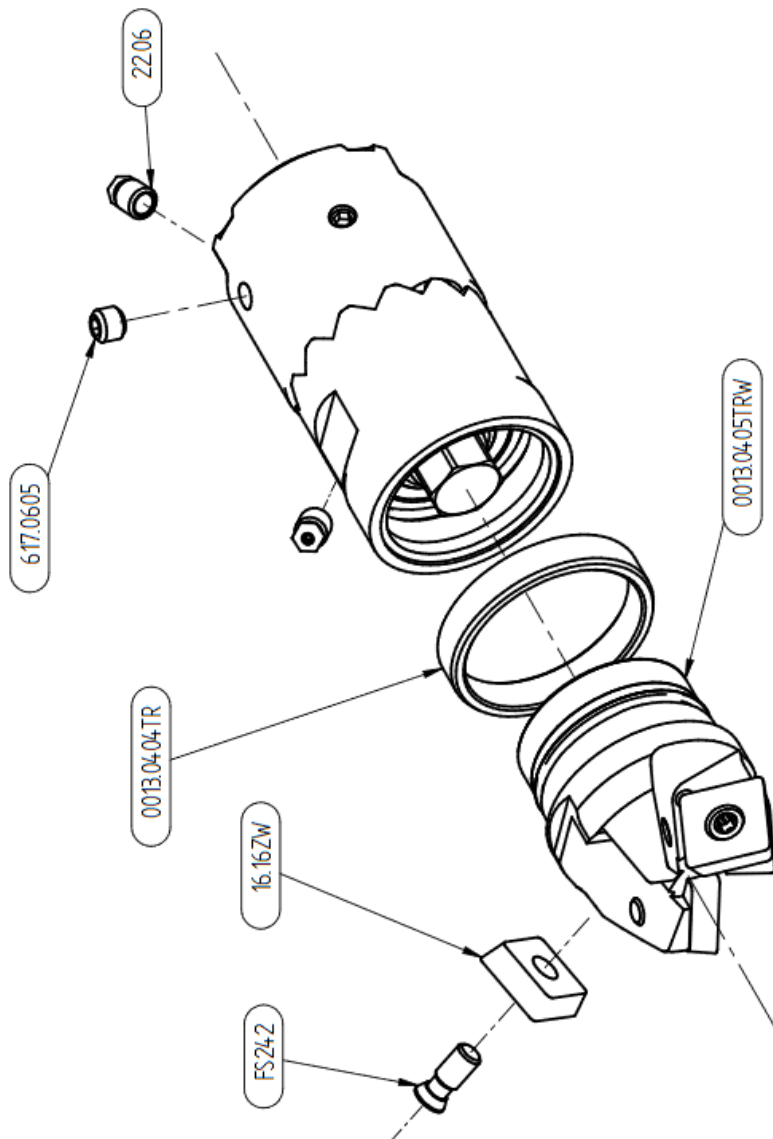

Drawing 2: Explosion 13.040TR

8.3 13.060TR

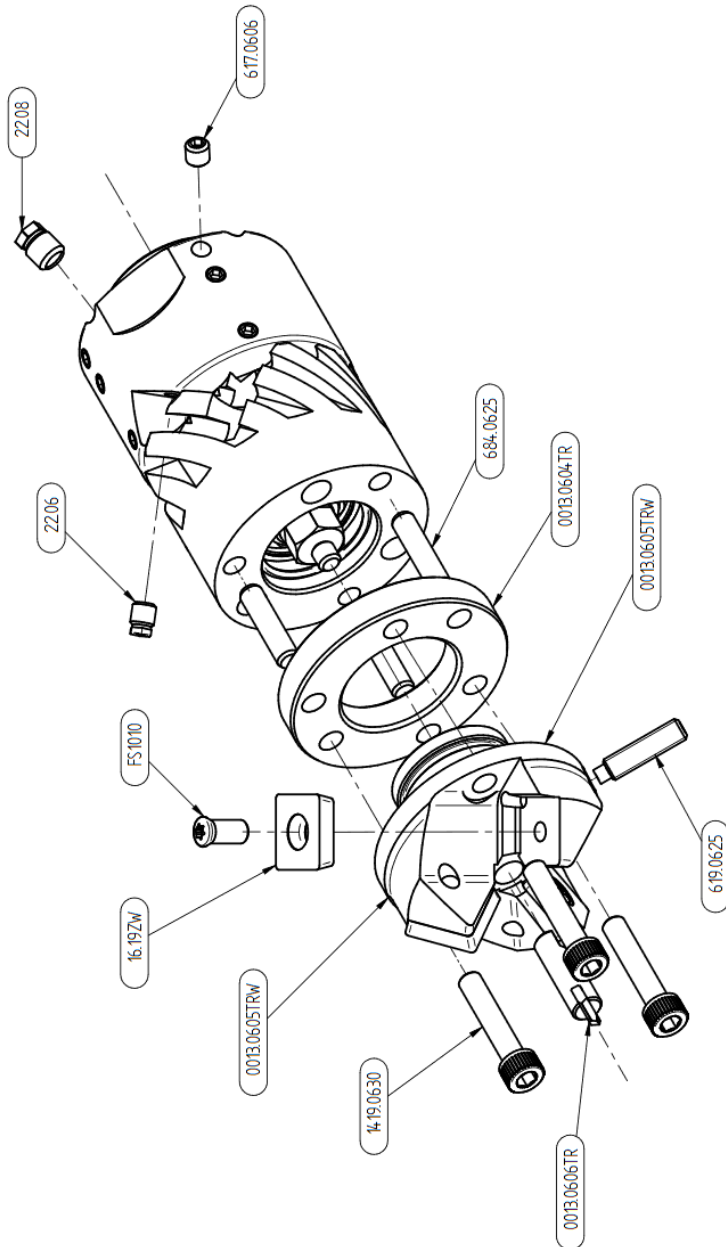

Drawing 3: Explosion 13.060TR



8.4 Accessories











8.4.1 13028

| Figure | Quantity | Article number | Designation |
|---|----------|--|-----------------------------------|
|  | 1 | 0010.0285M | Milling head with knife and screw |
| | 1 | 0010.0285 | Cover |
| | 2 | 3.0406T | Cylinder screw |
|  | 1 | 0010.028050K (pipe ø 50 mm) 0010.028075K (pipe ø 75 mm) 0010.028100K (pipe ø 100 mm) | Link chain |
|  | 1 | 0010.028050G (pipe ø 50 mm) 0010.028075G (pipe ø 75 mm) 0010.028100G (pipe ø 100 mm) | Pin bolt chain |
|  | 2 | 617.0612 | Threaded pin for link chain |
|  | 1 | 0010.0286 | Ball cage |
| | 6 | 22.04 | Nozzle insert |

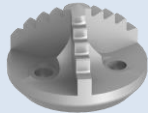
Table 5: Accessories 13.028

8.4.2 13.040TR

| Figure | Quantity | Article number | Designation |
|---|----------|----------------|---|
|  | 1 | 0013.0405TR | Milling head for recycling milling cutter |
| | 1 | OR32.0150 | O-ring |
|  | 3 | 16.16ZW | Carbide cutter plate |
|  | 3 | FS242 | Screw for cutter plate |
| | 1 | 0010.0603TR | Rotor |

| | | | |
|---|---|--|---|
|  | 1 | 0013.0404TR | Standard wear ring |
|  | 1 | 0013.0404TR-48 | Wear ring for plastic pipes |
|  | 1 | 0013.0407TR-48 | Wear-resistant ring |
|  | 4 | 1593.0606 | Oval head screw |
| | 4 | 617.0605 | Threaded pin |
|  | 1 | 0010.0605TRM | Cover with root knife |
| | 3 | 1419.0510T | Cylinder screw |
|  | 1 | 0010.0405 | Cover without knife |
|  | 1 | 0010.0407 | Plastic ball cage |
|  | 2 | 3.0612 | Cylinder head screw for plastic ball cage |
|  | 1 | 0010.0607TR | Cage without skids |
|  | 2 | 3.0606 | Cylinder head screw for cage |
|  | 1 | 0010.060710TR (pipe ø 100 mm) 0010.060712TR (pipe ø 125 mm) 0010.060715TR (pipe ø 150 mm) 0010.060720TR (pipe ø 200 mm) | Set of skids |
| | 4 | 56.0616 | Cylinder head screw for skids |
| | 1 | 0010.0604TR | Chain holder |





| | | | |
|---|---|--|------------------------|
|  | 1 | 0010.040060K (pipe ø 60 mm) 0010.040075K (pipe ø 75 mm) 0010.040100K (pipe ø 100 mm) 0010.040125K (pipe ø 125 mm) 0010.040150K (pipe ø 150 mm) 0010.040200K (pipe ø 200 mm) | Set of link chains |
| | 1 | 0010.0406 | Set of link chain pins |
|  | 1 | 0010.060060G (pipe ø 60 mm) 0010.060075G (pipe ø 75 mm) 0010.060100G (pipe ø 100 mm) 0010.060125G (pipe ø 125 mm) 0010.060150G (pipe ø 150 mm) 0010.060200G (pipe ø 200 mm) | Set of pin bolt chains |
| | 6 | 22.06 | Nozzle insert |

Table 6: Accessories 13.040TR

8.4.3 13.060TR

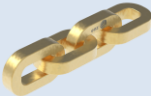
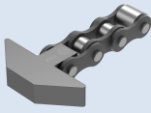
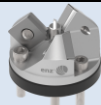
| Figure | Quantity | Article number | Designation |
|---|----------|----------------|---|
|  | 1 | 0013.0605TR | Milling head for recycling milling cutter |
| | 1 | OR28.0200 | O-ring |
| | 3 | 1419.0630 | Cylinder screw |
| | 3 | 684.0625 | Cylinder pin |
|  | 3 | 16.19ZW | Carbide cutter plate |
|  | 3 | FS1010 | Screw for cutter plate |
|  | 1 | 0013.0606TR | Exchangeable centre |
| | 1 | 619.0625 | Threaded pin |
|  | 1 | 0013.0604TR | Standard wear ring |
|  | 1 | 0013.0604TR-68 | Wear ring for plastic pipes |

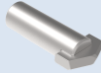
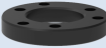
| | | | |
|---|---|---|------------------------|
|  | 1 | 0013.0607TR-68 | Wear-resistant ring |
|  | 4 | 1593.0606 | Oval head screw |
| | 4 | 617.0605 | Threaded pin |
|  | 1 | 0010.1254TR | Root knife |
| | 3 | 57.0604T | Hexagon head screw |
|  | 1 | 0010.1257TR | Cage |
| | 4 | 1593.0608 | Oval head screw |
|  | 1 | 0010.125710TR (pipe ø 100 mm) 0010.125712TR (pipe ø 125 mm) 0010.125715TR (pipe ø 150 mm) 0010.125720TR (pipe ø 200 mm) 0010.125722TR (pipe ø 225 mm) 0010.125725TR (pipe ø 250 mm) 0010.125730TR (pipe ø 300 mm) | Set of skids |
| | 4 | 622.0620 | Hexagon head screw |
| | 1 | Chain holder | 0010.1255TR |
|  | 1 | 0010.125100K (pipe ø 100 mm) 0010.125125K (pipe ø 125 mm) 0010.125150K (pipe ø 150 mm) 0010.125200K (pipe ø 200 mm) 0010.125225K (pipe ø 225 mm) 0010.125250K (pipe ø 250 mm) 0010.125300K (pipe ø 300 mm) | Set of link chains |
|  | 1 | 0010.0406 | Set of link chain pins |
|  | 1 | 0010.125100G (pipe ø 100 mm) 0010.125125G (pipe ø 125 mm) 0010.125150G (pipe ø 150 mm) 0010.125200G (pipe ø 200 mm) 0010.125225G (pipe ø 225 mm) | Set of pin bolt chains |

| | | | |
|---|---|--|------------------------|
| | | 0010.125250G (pipe ø 250 mm) 0010.125300G (pipe ø 300 mm) | |
|  | 1 | 0010.125150SE (pipe ø 150 mm) 0010.125200SE (pipe ø 200 mm) 0010.125225SE (pipe ø 225 mm) 0010.125250SE (pipe ø 250 mm) | Set of rope brushes |
| | 2 | 22.06 | Nozzle insert (drive) |
| | 4 | 22.08 | Nozzle insert (thrust) |

Table 7: Accessories 13.060TR

9 Directory

9.1 Tables

| | |
|---|----|
| <i>Table 1: Legend for technical data</i> | 14 |
| <i>Table 2: Technical data 13.028</i> | 15 |
| <i>Table 3: Technical Data 13.040TR</i> | 15 |
| <i>Table 4: Technical Data 13.060TR</i> | 15 |
| <i>Table 5: Accessories 13.028</i> | 40 |
| <i>Table 6: Accessories 13.040TR</i> | 42 |
| <i>Table 7: Accessories 13.060TR</i> | 44 |

9.2 Figures

| | |
|---|----|
| <i>Figure 1: Designation of the parts</i> | 14 |
| <i>Figure 2: Operating principle 13.060TR</i> | 18 |
| <i>Figure 3: Converting milling cutter 13.040TR for plastic pipes</i> | 21 |
| <i>Figure 4: Converting milling cutter 13.060TR for plastic pipes</i> | 22 |
| <i>Figure 5: Converting 13.028 to chain scraper</i> | 24 |
| <i>Figure 6: Converting 13.040TR to chain scraper</i> | 26 |
| <i>Figure 7: Converting 13.060TR to chain scraper</i> | 28 |
| <i>Figure 8: Changing the nozzle insert</i> | 30 |
| <i>Figure 9: Changing the carbide plates</i> | 31 |
| <i>Figure 10: Change milling cutter head 13.028</i> | 32 |
| <i>Figure 11: Change milling cutter head 13.040TR</i> | 33 |
| <i>Figure 12: Change milling cutter head 13.060TR</i> | 35 |
| <i>Figure 13: Change the exchangeable centre</i> | 36 |

9.3 Drawings

| | |
|--|----|
| <i>Drawing 1: Explosion 13.028</i> | 37 |
| <i>Drawing 2: Explosion 13.040TR</i> | 38 |
| <i>Drawing 3: Explosion 13.060TR</i> | 39 |

A large, dynamic splash of clear blue water with many bubbles, moving from the right side of the page towards the left, creating a sense of motion and freshness.

enz® technik ag
Schwerzbachstrasse 10
CH-6074 Giswil / Switzerland
Tel. +41 41 676 77 66
Fax +41 41 676 77 67
info@enz.com
www.enz.com